

Building drainage

# TECHNICAL MANUAL

POLO-KAL NG . POLO-KAL 35 . POLO-CLIP . POLO-CLIP HS  
POLO-KAL NG ASV . POLO-BSM



PURE  
PROGRESS / **poloplast**



# CONTENTS

## Standards, approvals and tests

1.1	General information .....	6
1.1.1	POLO-KAL NG . Highly noise-insulated building drainage system .....	6
1.1.2	POLO-KAL 3S . Highly noise-insulated building drainage system .....	7
1.2	Standards.....	8
1.2.1	POLO-KAL NG and POLO-KAL 3S .....	8
1.2.2	POLO-BSM .....	8
1.3	Technical tests of specific applications .....	8
1.3.1	POLO-KAL NG .....	8
1.3.2	POLO-KAL 3S .....	9
1.4	Approvals .....	9

## Pipe systems

2.1	POLO-KAL NG and POLO-KAL 3S – Fields of application .....	10
2.2	POLO-KAL NG .....	12
2.2.1	Technical data .....	12
2.2.2	Product range.....	13
2.2.3	POLO-KAL NG ASV – Extraction-proof connection .....	26
2.3	POLO-KAL 3S .....	30
2.3.1	Technical data .....	30
2.3.2	Product range.....	31
2.4	Connections to pipe systems made of other materials.....	36
2.5	POLO-EHP control .....	40
2.5.1	Easy maintenance and cleaning .....	40
2.5.2	Standard requirements .....	40
2.5.3	Product range.....	41
2.6	Pipe fastening elements.....	42
2.6.1	POLO-CLIP HS.....	42
2.6.2	POLO-CLIP .....	43
2.6.3	RBT screw clamp .....	44
2.6.4	Fastening set .....	44

## Fire protection

3.1	General information .....	45
3.1.1	Standards and regulations.....	45
3.1.2	Purpose of fire protection .....	45
3.2	Definitions.....	46
3.2.1	Fire protection plan .....	46
3.2.2	Construction products directive.....	46
3.2.3	Fire compartments .....	46
3.2.4	Structural elements that form fire compartments .....	46
3.3	Fire protective collar.....	47
3.3.1	POLO-BSM .....	47
3.3.2	Product range.....	49

# CONTENTS

## Sound protection

4.1	General information .....	50
4.1.1	Superposition of sound sources .....	50
4.1.2	Types of sound transmission .....	51
4.1.3	The purpose of noise insulation .....	51
4.1.4	Noise protection during the planning stage.....	51
4.2	The influence of the wall weight on sound protection.....	52
4.3	Sound level measurements .....	53

## Pipe insulation

5.1	General information .....	55
5.2	Heat insulation.....	55
5.3	Insulation preventing condensate development .....	55
5.4	Sound insulation.....	56
5.4.1	Insulating against airborne noise.....	56
5.4.2	Insulating against structure-borne noise .....	56

## Pipe system – Laying instructions

6.1	Transportation and storage.....	57
6.1.1	Loading and transportation .....	57
6.1.2	Unloading and storage .....	57
6.1.3	Outdoor exposure .....	57
6.2	Cutting to length and bevelling .....	58
6.2.1	Cutting to length.....	58
6.2.2	Bevelling.....	58
6.3	Information on push-fit connections.....	59
6.3.1	Linear expansion in single and multi-family homes .....	59
6.3.2	Linear expansion in construction projects, commerce and industry.....	59
6.3.3	Establishing the push-fit connection .....	59
6.4	Fastening with brackets.....	60
6.4.1	Arrangement of the brackets .....	60
6.4.2	Maximum distance between brackets .....	60
6.4.3	The use of steel clamps with rubber inserts.....	61
6.5	Information on pipe laying.....	62
6.5.1	Use in commercial kitchens .....	62
6.5.2	Installing pipes in concrete.....	62
6.5.3	Wall and ceiling installations.....	62
6.5.4	Installing pipes in brickwork (chases) .....	62
6.5.5	Examples of installation in a gap.....	63
6.5.6	Laying pipes on unfinished floors.....	64
6.5.7	Laying pipes in pits.....	64
6.5.8	Laying pipes in suspended ceilings .....	64

# CONTENTS

6.6	Special installation cases.....	65
6.6.1	Subsequent installation of branch pipes .....	65
6.6.2	Installing level double corner branch pipes .....	66
6.6.3	Installing bent double branch pipes .....	66
6.6.4	Installing condensate discharge elements .....	66
6.6.5	Installing condensate discharge elements DN 100/ DN/OD 110 to 1/2".....	67
6.6.6	Installing inside/inside transition pipes .....	68
6.6.7	Installing circular ventilation bends.....	69
6.6.8	Installing parallel branch pipes.....	69
6.6.9	Welding device for repair work.....	70
6.7	Declaration of Performance (DoP) and CE marking .....	71

## Texts for tenders

7.1	Texts for tenders.....	72
7.1.1	Text modules for POLO-KAL NG .....	72
7.1.2	Text modules for POLO-KAL 3S.....	73
7.1.3	Text modules for POLO-KAL NG ASV .....	75
7.1.4	Text modules for POLO-BSM .....	75
7.1.5	Text modules for POLO-CLIP HS.....	75

## General information

The data contained in the present manual are to help you to select our products for your purposes. Texts and illustrations have been collated with utmost care. Nevertheless, errors cannot be ruled out entirely. POLOPLAST cannot take any kind of responsibility for incorrect information and its consequences. POLOPLAST shall be grateful for any suggestions for improvement.

For further information, please do not hesitate to contact our technical field service. Or contact our head office at: +43 (0)732 / 38 86-0, office@poloplast.com

# STANDARDS, APPROVALS AND TESTS

## 1.1 General information

### 1.1.1 POLO-KAL NG . Highly noise-insulated building drainage system



#### 1. External layer made of PP

The tough protective shell of the pipe. Sturdy and highly impact resistant.

#### 2. Intermediate layer made of mineral-reinforced PP

Mineral-reinforced plastic provides high stability and establishes the superior noise-insulating effect of POLO-KAL NG.

#### 3. Internal layer made of PP

Tremendous surface smoothness and resistance to chemical agents.

POLO-KAL NG – A world class pipe. Installed a million times over, it has also proven itself a million times over.

### The advantages of POLO-KAL NG

- **Outstanding noise insulation values**

The tried and tested 3-layer technology reliably absorbs all flow noise.

- **High degree of rigidity**

For a high level of safety at construction sites, stability and easy installation.

- **Extremely tough**

Achieves top values in tests assessing flexural rigidity and impact resistance (to  $-20\text{ }^{\circ}\text{C}$ ), hot water resistance (short term:  $97\text{ }^{\circ}\text{C}$ /long term  $95\text{ }^{\circ}\text{C}$ ), low linear expansion, high chemical resistance.

- **Smooth inner surface**

Prevents the accumulation of deposits.

- **Precision sealing system**

Precisely-shaped push-fit sockets. Rapid assembly. Durable connection.

- **20 year guarantee**

Uncompromising quality, guaranteed by us (Guarantee Statement dated 11.10.2007).

- **25 years of multi-layer technology experience**

POLOPLAST has more than 25 years of knowledge and experience with the tried and tested 3-layer technology and 60 years of experience with building drainage.

- **Many possible applications and a comprehensive product range**

A virtually endless number of application possibilities due to the large number of system components available in the dimensions DN 32–250.

- **Pipes can be laid underground within the boundaries of the property**

Particularly suitable thanks to the high level of ring rigidity.



# STANDARDS, APPROVALS AND TESTS

## 1.1.2 POLO-KAL 3S . Highly noise-insulated building drainage system

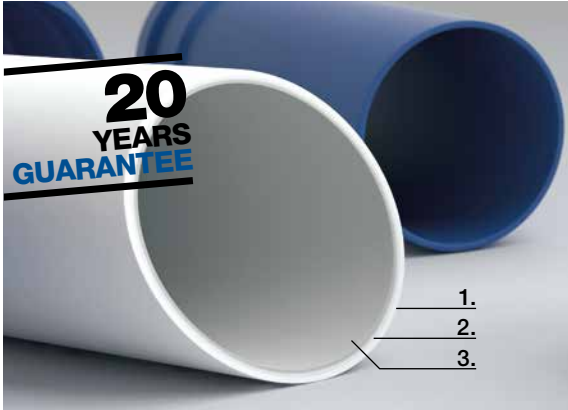

### 1. External layer made of PP

The tough protective shell of the pipe. Sturdy and highly impact resistant.

### 2. Intermediate layer made of mineral-reinforced PP

Mineral-reinforced plastic provides very high stability and establishes the superior noise-insulating effect of POLO-KAL 3S.

### 3. Internal layer made of PP

Tremendous surface smoothness and resistance to chemical agents.

When sound insulation is a top priority – for example in downpipes or in the case of specific noise insulation requirements – professionals choose our highly noise-insulated POLO-KAL 3S pipe system.

### The advantages of POLO-KAL 3S

- **Outstanding noise insulation values**  
Achieves top results in the absorption of flow noise.
- **Tried and tested 3-layer technology**  
Guarantees the reliable and noise-insulating performance of the pipe system.
- **Extremely tough**  
High flexural rigidity and impact resistance, hot water resistance (short term: 97 °C/long term 95 °C). High chemical resistance. Minimal linear expansion.
- **Precision sealing system**  
Precisely-shaped push-fit sockets. Rapid assembly. Durable connection.
- **Smooth inner surface**  
Prevents the accumulation of deposits.
- **20 year guarantee**  
Uncompromising quality, guaranteed by us (Guarantee Statement dated 11.10.2007).
- **25 years of multi-layer technology experience**  
POLOPLAST has more than 25 years of knowledge and experience with the tried and tested 3-layer technology and 60 years of experience with building drainage.



# STANDARDS, APPROVALS AND TESTS

## 1.2 Standards

### 1.2.1 POLO-KAL NG and POLO-KAL 3S

<a href="#">EN 12056 PARTS 1-5</a>	Gravity discharge systems within buildings
<a href="#">DIN 1986 PART 100</a>	Drainage systems for buildings and plots. Part 100: Regulations linked to DIN EN 752 and DIN EN 12056
<a href="#">EN 14366</a>	Laboratory measurement of noise from wastewater installations
<a href="#">DIN 4109</a>	Sound insulation in building constructions
<a href="#">VDI 4100</a>	Sound insulation in residential buildings

### 1.2.2 POLO-BSM

<a href="#">EN 1366-3</a>	Fire resistance tests for service installations – penetration seals
<a href="#">EN 13501-2</a>	Fire classification of construction products and design types Part 2: Classification using data from reaction to fire tests, not including ventilation systems
<a href="#">DIN 4102-11</a>	Fire behaviour of building materials and building components

## 1.3 Technical tests of specific applications

### 1.3.1 POLO-KAL NG

<a href="#">TGM-VA KU 25 000/1</a>	Resistance to external impact, tested in stepped tests at –20 °C
<a href="#">SIEGEN IB-WED 2003.4</a>	Charging tests of ventilation pipes (Controlled housing ventilation, centralised vacuum cleaning system)
<a href="#">SIEGEN G02-146/2</a>	Assessment and comparison of loss of pressure for plastic pipe sections and fittings of ventilation pipes (Controlled housing ventilation, centralised vacuum cleaning system)
<a href="#">OFI 47.423</a>	Coefficient of linear expansion of plastic pipe sections
<a href="#">ÖKI 33.044</a>	Resistance to low pressure
<a href="#">OFI 409.653-1K</a>	Emission measurements on inner pipe layers following VDA 278
<a href="#">OFI 409.653-2K</a>	Emission measurements on POLO-KAL NG fittings and seals following VDA 278



# STANDARDS, APPROVALS AND TESTS

**ING. BERNHARD HAMMER**  
(Engineer) **OCTOBER 2001**

Comparison of labour and time required  
“Push-fit and welding in drainage pipe systems”

**OFI 311.480**

Dynamic pressure tests of extraction-proof connections

**ZF-Steyr Werkstofftechnik**  
**A-SQ 24.05.2006**

Proof of radon impermeability

## 1.3.2 POLO-KAL 3S

**OFI 47.423**

Coefficient of linear expansion of plastic pipe sections

## 1.4 Approvals

**Germany**

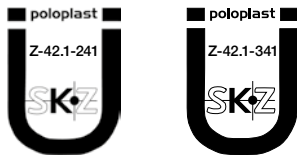

**POLO-KAL NG:** DIBt Approval No. Z-42.1-241  
**POLO-KAL 3S:** DIBt Approval No. Z-42.1-341

**Austria**



TGM KU 15.300

**Norway**



**POLO-KAL NG:** Approval No. NPS 0396  
**POLO-KAL 3S:** Pipe Approval No. PS 0697  
Fittings Approval No. PS 0702

**Sweden**

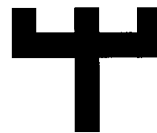

**POLO-KAL NG:** Approval No. 0704/99  
**POLO-KAL 3S:** Approval No. 0990/99

**Czech Republic**



**POLO-KAL NG:** Approval No. 04 0743 V/AO  
**POLO KAL 3S:** Approval No. 01 0557 V/AO

**Slovak Republic**



**POLO-KAL NG:**  
Approval No. 0901A/02/0016/1/C/C06

# PIPE SYSTEMS

STANDARDS, APPROVALS  
AND TESTS

PIPE SYSTEMS

FIRE PROTECTION

SOUND PROTECTION

PIPE INSULATION

PIPE SYSTEM – LAYING  
INSTRUCTIONS

TEXTS FOR TENDERS

## 2.1 POLO-KAL NG and POLO-KAL 3S – Fields of application

Many challenges. One solution. POLO-KAL®

Pipes ensure the efficient supply and discharge throughout the entire building and provide for a high level of living comfort – there is no room for compromises. The POLOPLAST pipe systems deliver a convincing performance from the roof to the cellar, offering maximum reliability. For the decades past and the decades ahead.





1

## Highly noise-insulated building drainage system

### POLO-KAL NG . POLO-KAL 3S

As high-quality building drainage system POLO-KAL NG, the noise-insulated plastic pipe using the innovative 3-layer technology, delivers a convincing performance distinguished by superior quality and excellent noise insulation values. Wherever particularly high sound protection is required, POLOPLAST offers a convincing solution with POLO-KAL 3S, its highly noise-insulated pipe system, specially designed for the downpipes of domestic waste disposal systems or in the case of specific noise insulation requirements.

2

## Controlled dwelling ventilation

### POLO-KWL

The fully developed complete system by POLOPLAST comprises planning, initial operation, service and cleaning. As all components are produced by a single source, seamless high quality is ensured, as well as the perfect interaction of all individual parts. Thanks to its high quality and excellent properties the POLO-KAL NG pipe system in particular is the tailor-made solution for controlled dwelling ventilation systems.

3

## Centralised vacuum cleaning installation

### POLO-ZSA

The product highlights of POLO-KAL NG, such as its innovative 3-layer structure, the smooth inner surface or the exact form of the sleeves, ensure the noiseless and efficient suction performance in the “centralised vacuum cleaning installation”.

4

## Pipe ducting

### POLO-RDS evolution

The pipe ducting system POLO-RDS evolution features many clever details and provides for the simple, secure and leak-proof ducting of cables and pipes through walls.

# PIPE SYSTEMS

## 2.2 POLO-KAL NG

### 2.2.1 Technical data

<b>Material</b>	<b>Pipe:</b> PP/PP-MV/PP; <b>Fitting:</b> PP-MV Free of halogen and cadmium, free of heavy metals
<b>Colour</b>	Blue RAL 5014
<b>Resistance to hot water</b>	Short-term 97 °C                      30 sec/day = 152 h/50 years Long-term 95 °C                      10 min/day = 3,000 h/50 years Long-term 60 °C                      5 h/day = 87,600 h/50 years
<b>Application category</b>	BD (building/drainage) Approved for gravity drainage systems inside and exterior to buildings in accordance with EN 1451-1 as well as DIN 1986-100 Suitable for underground laying to the plot boundary.
<b>Pipe marking</b>	Domestic waste disposal pipes of POLO-KAL NG denomination are marked in the following way: charge number, year and week of manufacture, company name, dimension, category of application, category of rigidity, certification marking and material specification.
<b>Chemical resistance</b>	Pipes and fittings made of PP – according to DIN 8078, supplement 1 Seals – according to ISO TR7620
<b>Connections</b>	Push-fit sockets with factory-inserted lip seals. Seal material = SBR (from DN/OD 200 it is NBR)
<b>Fire behaviour</b>	According DIN 4102: B2, Q1, TR1 According EN 13501-1: D-s2, d1
<b>Ring rigidity</b>	The ring rigidity of the pipe has been proved according to EN ISO 9969. The rigidity is at least 6.0 kN/m <sup>2</sup> over the entire range of dimensions DN/OD 32 – 160 mm. The ring rigidity of DN/OD 200 and 250 mm is at least 8.0 kN/m <sup>2</sup> .
<b>Leakproofness at low pressure</b>	Short-term to 900 mbar
<b>E-modulus</b>	2400–3100 MPa according to ISO 178
<b>Leakproofness</b>	According to EN 1451-1, test report TGM VA KU 2164
<b>Mean coefficient of elongation LAK</b>	0.05 mm/m K (OFI test report No. 47.423)
<b>Low-temperature impact strength</b>	❄ to –20 °C, safe transportation and laying, even at low temperatures (Test report TGM VA KU 25000/1)
<b>Third-party monitoring of – product quality</b>	POLO-KAL NG pipes and fittings are third-party monitored by authorised German and Austrian plastics testing institutes.
<b>Drinking water suitability</b>	POLO-KAL NG is not approved for the transportation of drinking water.

# PIPE SYSTEMS

## 2.2.2 Product range

Dimensions in mm

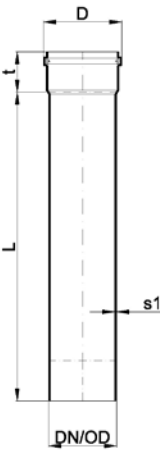
POLO-KAL NG Socket pipe PKEM with factory-fitted lip ring	DN/OD*	Item No.	L	s1(min)	t(min)	D(max)	kg/pc.
							
	32	02000	150	1.8	41	41	0.03
	32	02001	250	1.8	41	41	0.05
	32	02002	500	1.8	41	41	0.10
	32	02003	1000	1.8	41	41	0.21
	32	02004	1500	1.8	41	41	0.31
	32	02005	2000	1.8	41	41	0.41
	40	02010	150	1.8	45	53	0.04
	40	02011	250	1.8	45	53	0.07
	40	02012	500	1.8	45	53	0.13
	40	02019	750	1.8	45	53	0.20
	40	02013	1000	1.8	45	53	0.26
	40	02014	1500	1.8	45	53	0.39
	40	02015	2000	1.8	45	53	0.52
	40	02016	3000	1.8	45	53	0.78
	50	02020	150	2.0	47	63	0.06
	50	02021	250	2.0	47	63	0.09
	50	02022	500	2.0	47	63	0.19
	50	02029	750	2.0	47	63	0.28
	50	02023	1000	2.0	47	63	0.37
	50	02024	1500	2.0	47	63	0.56
	50	02025	2000	2.0	47	63	0.74
	50	02026	3000	2.0	47	63	1.12
	75	02030	150	2.6	53	89	0.11
	75	02031	250	2.6	53	89	0.19
	75	02032	500	2.6	53	89	0.38
	75	02039	750	2.6	53	89	0.56
	75	02033	1000	2.6	53	89	0.75
	75	02034	1500	2.6	53	89	1.13
	75	02035	2000	2.6	53	89	1.51
	75	02036	3000	2.6	53	89	2.26
	75	02037	4000	2.6	53	89	3.01
	90	02070	150	3.0	57	106	0.16
	90	02071	250	3.0	57	106	0.26
	90	02072	500	3.0	57	106	0.53
	90	02079	750	3.0	57	106	0.79
	90	02073	1000	3.0	57	106	1.06
	90	02074	1500	3.0	57	106	1.58
	90	02075	2000	3.0	57	106	2.11
	90	02076	3000	3.0	57	106	3.17
	90	02077	4000	3.0	57	106	4.22

STANDARDS, APPROVALS  
AND TESTS

PIPE SYSTEMS

FIRE PROTECTION

SOUND PROTECTION

PIPE INSULATION

PIPE SYSTEM - LAYING  
INSTRUCTIONS

TEXTS FOR TENDERS

\* DN/OD – according to European standardisation CEN/TC 155: Dimension Nominal / Outside Diameter

Subject to technical alterations

# PIPE SYSTEMS

Dimensions in mm

STANDARDS, APPROVALS  
AND TESTS

PIPE SYSTEMS

FIRE PROTECTION

SOUND PROTECTION

PIPE INSULATION

PIPE SYSTEM - LAYING  
INSTRUCTIONS

TEXTS FOR TENDERS

## POLO-KAL NG Socket pipe PKEM

with factory-fitted lip ring

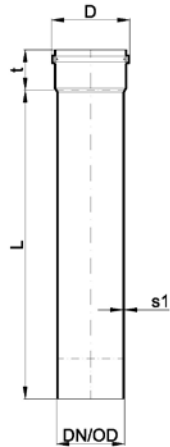

DN/OD	Item No.	L	s1(min)	t(min)	D(max)	kg/pc.
110	02040	150	3.4	62	128	0.22
110	02041	250	3.4	62	128	0.37
110	02042	500	3.4	62	128	0.74
110	02049	750	3.4	62	128	1.11
110	02043	1000	3.4	62	128	1.49
110	02044	1500	3.4	62	128	2.23
110	02045	2000	3.4	62	128	2.97
110	02046	3000	3.4	62	128	4.46
110	02047	4000	3.4	62	128	5.94
125	02050	150	3.9	67	145	0.29
125	02051	250	3.9	67	145	0.48
125	02052	500	3.9	67	145	0.97
125	02053	1000	3.9	67	145	1.94
125	02054	1500	3.9	67	145	2.91
125	02055	2000	3.9	67	145	3.88
125	02056	3000	3.9	67	145	5.82
125	02057	4000	3.9	67	145	7.76
160	02060	150	4.9	77	184	0.47
160	02061	250	4.9	77	184	0.79
160	02062	500	4.9	77	184	1.58
160	02063	1000	4.9	77	184	3.16
160	02064	1500	4.9	77	184	4.74
160	02065	2000	4.9	77	184	6.32
160	02066	3000	4.9	77	184	9.47
160	02067	4000	4.9	77	184	12.63
200	02951	1000	6.8	122	228	5.78
200	02953	3000	6.8	122	228	17.34
200	02954	6000	6.8	122	228	32.70
250	02956	1000	8.6	156	289	9.29
250	02959	3000	8.6	156	289	27.87

Subject to technical alterations

# PIPE SYSTEMS

Dimensions in mm

**POLO-KAL NG Bend  
PKB**  
with factory-fitted lip ring

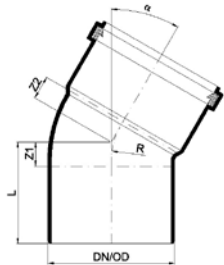

	DN/OD	Item No.	Z1	Z2	R	L	kg/pc.
15°	32	02100	3	7	18	44	0.03
	40	02110	7	8	21	51	0.04
	50	02120	7	8	27	56	0.05
	75	02130	9	10	40	64	0.12
	90	02170	13	8	47	73	0.16
	110	02140	13	13	57	80	0.26
	125	02150	12	13	90	85	0.36
	160	02160	36	16	115	121	0.72
	200	02960	13	23	120	131	1.56
30°	32	02101	5	9	18	46	0.03
	40	02111	10	11	21	54	0.04
	50	02121	11	12	27	60	0.06
	75	02131	15	15	40	70	0.12
	90	02171	13	19	47	72	0.17
	110	02141	21	20	58	88	0.28
	125	02151	20	22	90	93	0.39
	160	02161	25	28	115	133	0.80
	200	02962	48	37	120	144	1.70
45°	32	02102	7	12	18	48	0.03
	40	02112	13	14	21	57	0.04
	50	02122	15	16	27	63	0.06
	75	02132	21	21	40	75	0.15
	90	02172	26	20	47	85	0.19
	110	02142	49	29	57	116	0.36
	125	02152	50	31	90	124	0.43
	160	02162	60	41	115	145	0.78
	200	02963	66	52	120	183	1.85
	250	02968	113	152	segments	270	5.02
67.5°	32	02103	12	16	18	52	0.03
	40	02113	18	19	21	62	0.05
	50	02123	22	22	27	70	0.06
	75	02133	31	31	40	86	0.13
	90	02173	33	27	47	92	0.21
	110	02143	44	44	58	111	0.33
	125	02153	46	48	90	119	0.49
	160	02163	59	62	115	144	0.90
87.5°	32	02104	16	20	18	57	0.03
	40	02114	24	25	21	68	0.05
	50	02124	29	30	27	78	0.07
	75	02134	42	42	40	97	0.15
	90	02174	50	42	47	109	0.22
	110	02144	60	60	58	128	0.37
	125	02154	64	66	90	138	0.53
	160	02164	84	87	115	169	0.98
	200	02965	106	115	125	230	2.36
	250	02970	236	275	segments	392	6.32

Subject to technical alterations

STANDARDS, APPROVALS  
AND TESTS

PIPE SYSTEMS

FIRE PROTECTION

SOUND PROTECTION

PIPE INSULATION

PIPE SYSTEM - LAYING  
INSTRUCTIONS

TEXTS FOR TENDERS

# PIPE SYSTEMS

Dimensions in mm

STANDARDS, APPROVALS  
AND TESTS

PIPE SYSTEMS

FIRE PROTECTION

SOUND PROTECTION

PIPE INSULATION

PIPE SYSTEM – LAYING  
INSTRUCTIONS

TEXTS FOR TENDERS

## POLO-KAL NG Branch PKEA with factory-fitted lip ring

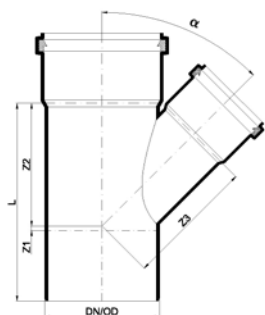

45°

DN/OD	Item No.	Z1	Z2	Z3	L	kg/pc.
32/32	02200	7	45	45	93	0.05
40/32	02203	7	49	50	100	0.07
40/40	02206	13	54	54	111	0.08
50/32	02209	2	54	57	104	0.08
50/40	02212	8	59	61	115	0.10
50/50	02215	15	66	66	129	0.11
75/50	02218	3	80	84	138	0.20
75/75	02221	21	98	98	173	0.28
90/50	02210	-2	84	92	142	0.26
90/75	02834	14	114	117	187	0.35
90/90	02211	25	112	112	196	0.40
110/40	02204	-14	92	106	145	0.35
110/50	02224	-13	99	109	153	0.38
110/75	02227	5	117	123	189	0.48
110/90	02839	19	132	135	218	0.55
110/110	02230	47	144	144	259	0.67
125/75	02233	12	130	139	215	0.66
125/90	02843	28	161	183	262	1.02
125/110	02236	40	161	154	274	0.86
125/125	02239	50	161	160	284	0.96
160/90	02840	29	174	184	288	1.43
160/110	02242	29	174	184	287	1.26
160/125	02240	34	198	201	309	1.58
160/160	02245	59	209	209	353	1.83
200/160	02971	41	229	253	388	3.23
200/200	02973	59	240	240	423	4.00
250/160	02975	215	301	320	672	7.75
250/250	02979	144	361	363	669	10.32
67.5°						
40/40	02207	18	35	35	97	0.08
50/40	02213	16	36	40	101	0.09
50/50	02216	22	42	42	112	0.10
75/50	02219	17	49	56	121	0.18
75/75	02222	52	88	85	193	0.29
90/50	02835	14	69	71	143	0.40
90/75	02832	100	88	84	247	0.38
90/90	02831	36	77	76	172	0.35
110/50	02225	11	57	40	136	0.36
110/75	02228	25	71	82	163	0.43
110/90	02837	46	103	108	216	0.58
110/110	02231	44	93	92	203	0.58
125/90	02844	75	104	105	248	0.79
125/110	02237	63	116	117	248	0.83
160/110	02243	53	121	135	251	1.17

Subject to technical alterations



# PIPE SYSTEMS

Dimensions in mm

STANDARDS, APPROVALS  
AND TESTS

PIPE SYSTEMS

FIRE PROTECTION

SOUND PROTECTION

PIPE INSULATION

PIPE SYSTEM - LAYING  
INSTRUCTIONS

TEXTS FOR TENDERS

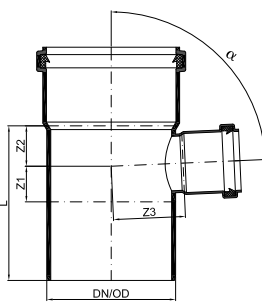
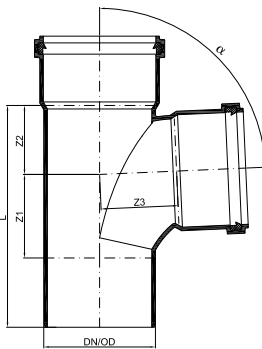
<b>POLO-KAL NG Branch PKEA</b> with factory-fitted lip ring		DN/OD	Item No.	Z1	Z2	Z3	L	kg/pc.
 	87.5°	40/40	02208	24	25	25	94	0.07
	50/40	02214	24	25	30	98	0.09	
	50/50	02217	29	30	30	108	0.10	
	75/50	02220	30	32	43	117	0.18	
	75/75	02223	42	45	45	142	0.23	
	90/50	02830	29	35	52	123	0.23	
	90/75	02833	47	49	50	156	0.34	
	90/90*	02248	70	59	64	189	0.29	
	110/50	02226	30	34	61	132	0.34	
	110/75	02229	43	48	63	158	0.42	
	110/90	02836	19	132	135	218	0.47	
	110/110*	02232	82	88	76	219	0.58	
	125/75	02235	96	83	84	249	0.63	
	125/90	02845	75	65	83	214	0.86	
	125/110	02238	67	76	75	216	0.71	
	125/125	02241	65	76	75	215	0.76	
	160/90	02842	81	95	135	261	1.89	
	160/110	02244	81	95	107	261	1.21	
	160/125	02246	78	97	103	251	1.28	
	160/160	02247	115	118	118	310	1.72	
200/160	02972	112	127	134	361	2.90		
200/200	02974	140	127	126	388	3.80		
250/160	02976	110	127	193	394	4.91		
250/250	02980	159	156	161	471	7.47		

\*) swept entry branch

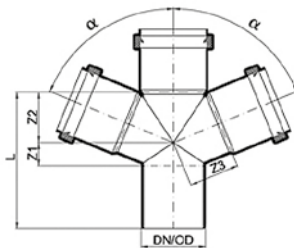
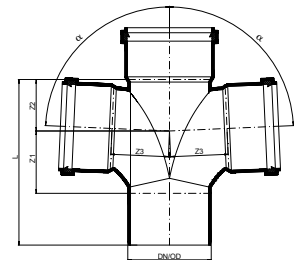
<b>POLO-KAL NG Double branch PKDA</b> with factory-fitted lip ring		DN/OD	Item No.	Z1	Z2	Z3	L	kg/pc.
 	45°/180°	75/50/50	02295	6	83	84	142	0.25
	75/75/75	02396	23	101	100	177	0.37	
	110/50/50	02258	-8	97	107	156	0.42	
	110/110/110	02259	29	147	145	243	0.89	
	125/110/110	02234	32	165	158	266	1.10	
	160/110/110	02399	9	183	188	269	1.48	
	67.5°/180°	90/50/50	02848	16	59	74	144	0.33
	90/90/90	02846	36	77	77	173	0.44	
	110/50/50	02260	14	57	78	139	0.38	
	110/110/110	02261	44	95	96	206	0.74	
125/110/110	02262	48	101	104	218	0.88		
160/110/110	02264	73	127	133	268	1.37		
87.5°/180°	90/90/90*	02847	49	59	59	168	0.44	
110/50/50	02255	31	37	69	135	0.38		
110/75/75	02269	44	50	66	160	0.48		
110/110/110*	02267	69	69	96	196	0.64		
125/110/110	02272	69	78	81	216	0.86		
160/110/110	02274	92	100	115	269	1.37		

\*) swept entry branch

Subject to technical alterations

# PIPE SYSTEMS

Dimensions in mm

STANDARDS, APPROVALS  
AND TESTS

PIPE SYSTEMS

FIRE PROTECTION

SOUND PROTECTION

PIPE INSULATION

PIPE SYSTEM – LAYING  
INSTRUCTIONS

TEXTS FOR TENDERS

**POLO-KAL NG**  
**Parallel branch PKPA**  
with factory-fitted lip ring

DN/OD	Item No.	Z1	Z2	Z3	Z4	L	L2	A	kg/pc.
90/90	02828	28	118	167	20	205	225	117	0.62
110/110	02294	29	144	200	29	240	224	141	0.81

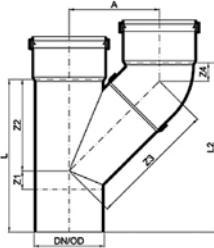

**POLO-KAL NG**  
**Double corner branch PKEDA**  
with factory-fitted lip ring

87.5°/90°

DN/OD	Item No.	Z1	Z2	Z3	Z4	L	kg/pc.
90/90/90	02829	52	60	57	68	167	0.43
110/110/110	02275	61	68	68	79	198	0.66
110/L110/R75	02277	62	69	57	69	198	0.60
110/L75/R110	02279	62	69	69	71	198	0.60
125/110/110	02276	67	76	83	75	216	0.86
160/110/110	02278	81	95	107	106	261	1.36

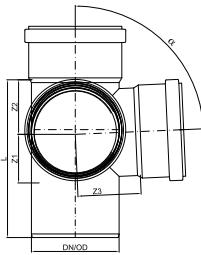

**POLO-KAL NG Double corner branch level PKEDA**  
with factory-fitted lip ring

87.5°

DN/OD	Item No.	Z1	Z2	Z3	Z4	L	kg/pc.
90/90/50	02826	49	60	52	52	168	0.41
90/50/90	02827	49	60	52	52	168	0.36
110/110/50	02291	60	69	67	77	197	0.57
110/50/110	02838	60	69	67	77	197	0.57

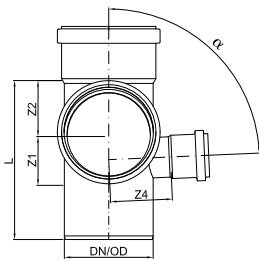

**POLO-KAL NG**  
**Vertical double branch PKVDA**  
with factory-fitted lip ring

87.5°

DN/OD	Item No.	Z1	Z2	Z3	Z4	Z5	L	kg/pc.
90/50/90	01945	29	108	59	52	52	255	0.46
110/50/90	01946	30	117	60	61	73	274	0.66
110/50/110	01947	30	123	69	61	67	290	0.71

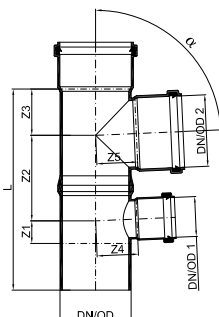

Subject to technical alterations

# PIPE SYSTEMS

Dimensions in mm

STANDARDS, APPROVALS  
AND TESTS

PIPE SYSTEMS

FIRE PROTECTION

SOUND PROTECTION

PIPE INSULATION

PIPE SYSTEM - LAYING  
INSTRUCTIONS

TEXTS FOR TENDERS

**POLO-KAL NG**  
**Double branch** 87.5°/180°  
**PKKA**  
with factory-fitted  
lip ring

DN/OD	Item No.	Z1	Z2	Z3	Z4	Z5	Z6	L	kg/pc.
110/L110/R75	02268	93	93	78	100	50	50	248	0.75
110/L75/R110	02273	93	93	100	78	50	50	248	0.75
110/110/110	02296	93	89	85	85	56	56	248	0.86

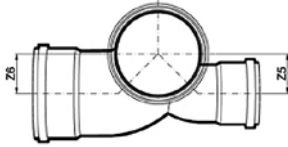

**POLO-KAL NG**  
**Single branch** 87.5°  
**inside/inside**

DN/OD1	DN/OD2	DN/OD3	Item No.	Z1	Z2	Z3	L	kg/pc.
110	110	50	01943	36	35	61	132.0	0.40
110	110	110	01944	62	67	67	190.3	0.58

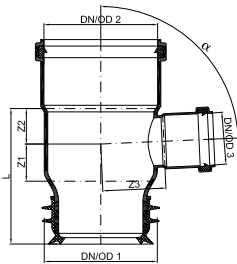

**POLO-KAL NG Reducer**  
**PKR**  
with factory-fitted lip ring

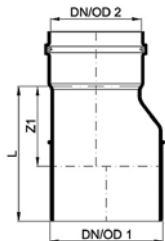

DN/OD1	DN/OD2	Item No.	Z1	L	kg/pc.
40	32	02280	23	65	0.03
50	32	02281	24	72	0.04
50	40	02282	20	65	0.05
75	50	02283	31	79	0.09
90	50	02885	34	90	0.13
90	75	02886	19	76	0.14
110	50	02284	47	113	0.19
110	75	02285	32	99	0.20
110	90	02887	26	88	0.21
125	110	02286	18	92	0.31
160	110	02287	39	124	0.51
160	125	02288	32	117	0.54
200	160	02981	47	171	1.31
250	200	02983	177	299	2.96

**POLO-KAL NG Reducer, short**  
**PKRK**

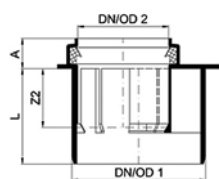

DN/OD	Item No.	Z2	A	L	kg/pc.
75/50	02875	33	17	54	0.08
90/50	02292	32	17	66	0.11
90/75	02289	37	17	61	0.12
110/50	02876	32	18	66	0.16
110/75	02877	38	19	66	0.16
110/90	02290	40	19	66	0.17
160/110	02878	58	19	89	0.43

Subject to technical alterations

# PIPE SYSTEMS

Dimensions in mm

STANDARDS, APPROVALS  
AND TESTS

PIPE SYSTEMS

FIRE PROTECTION

SOUND PROTECTION

PIPE INSULATION

PIPE SYSTEM – LAYING  
INSTRUCTIONS

TEXTS FOR TENDERS

## POLO-KAL NG Reducer PKRI inside/inside

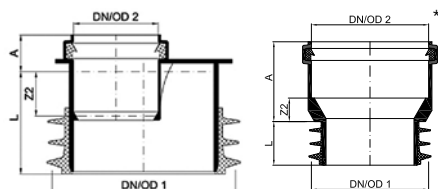

DN/OD	Item No.	Z2	A	L	kg/pc.
110/50	02369	-27	22	62	0.18
110/75	02370	-37	18	62	0.17
110/90	02367	4	67	51	0.21
110/110*	02381	22	75	41	0.28
160/110	02366	20	91	77	0.48

## POLO-KAL NG Reducer, centric PKRZ

with small spigot end,  
with factory-fitted lip ring

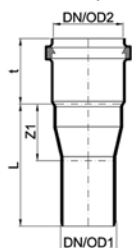

DN/OD1	DN/OD2	Item No.	L	t	Z1	kg/pc.
40	50	01786	88	47	41	0.06
50	75	01787	94	55	46	0.11
75	40	01785	84	55	45	0.09
90	110	01791	47	69	7	0.18

## POLO-KAL NG Cleaning pipe PKRE

with factory-fitted lip ring,  
pressure-sealed up to 0.5 bar

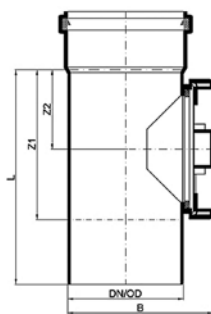

DN/OD	Item No.	Z1	Z2	B	L	kg/pc.
50	02342	68	33	63	116	0.09
75	02343	102	52	94	156	0.25
90	02347	115	55	116	174	0.40
110	02344	144	76	138	205	0.62
125	02345	187	89	165	256	0.72
160	02346	168	92	213	244	1.14
200	02992	236	117	238	358	2.62
250	02993	253	133	295	409	4.80

## POLO-KAL NG Long sleeve PKL

with factory-fitted double lip ring

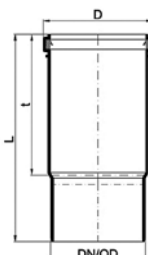

DN/OD	Item No.	L	D	t	kg/pc.
40	02331	158	53	107	0.06
50	02332	174	63	119	0.07
75	02333	198	89	136	0.18
90	02338	212	105	143	0.23
110	02334	243	127	165	0.37
125	02335	316	144	187	0.63
160	02336	328	182	215	1.02
200	02339	502	229	280	2.77
250	02340	621	289	347	5.39

Subject to technical alterations

# PIPE SYSTEMS

Dimensions in mm

STANDARDS, APPROVALS  
AND TESTS

PIPE SYSTEMS

FIRE PROTECTION

SOUND PROTECTION

PIPE INSULATION

PIPE SYSTEM - LAYING  
INSTRUCTIONS

TEXTS FOR TENDERS

## POLO-KAL NG Double socket PKD with factory-fitted lip ring

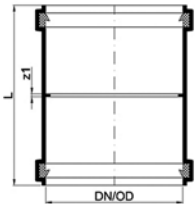

DN/OD	Item No.	L	Z1	kg/pc.
32	02300	87	2	0.03
40	02301	96	2	0.07
50	02302	104	2	0.06
75	02303	118	2	0.13
90	02307	127	2	0.17
110	02304	145	3	0.28
125	02305	157	4	0.40
160	02306	180	4	0.69
200	02986	240	4	1.53
250	02987	292	9	3.02

## POLO-KAL NG Sleeve socket PKU with factory-fitted double lip ring

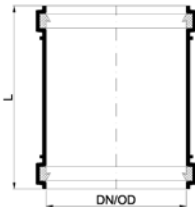

DN/OD	Item No.	L	kg/pc.
40	02311	96	0.05
50	02312	104	0.06
75	02313	118	0.13
90	02319	127	0.17
110	02314	145	0.28
125	02315	157	0.39
160	02316	180	0.68
200	02984	240	1.50

## POLO-KAL NG Socket plug PKM

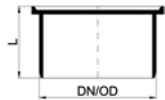

DN/OD	Item No.	L	kg/pc.
32	02320	32	0.01
40	02321	40	0.02
50	02322	44	0.02
75	02323	51	0.06
90	02327	55	0.08
110	02324	62	0.14
125	02325	81	0.19
160	02326	92	0.36
200	02990	122	0.85
250	02991	110	1.36

## POLO-KAL NG Recirculation bend 110/135 with factory-fitted lip ring

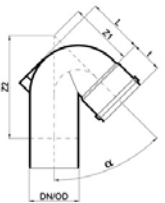

DN/OD	Item No.	L	D	t	kg/pc.
110	02145	124	69	142	0.572

## POLO-KAL NG Condensate discharge PKKO

connection to hose di 8 mm

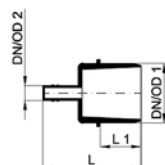

DN/OD1	DN/OD2	Item No.	L	L1	kg/pc.
32	8	02356	52	22	0.01

# PIPE SYSTEMS

Dimensions in mm

STANDARDS, APPROVALS  
AND TESTS

PIPE SYSTEMS

FIRE PROTECTION

SOUND PROTECTION

PIPE INSULATION

PIPE SYSTEM - LAYING  
INSTRUCTIONS

TEXTS FOR TENDERS

## POLO-KAL NG Condensate discharge for plastic pipes PKKO connection to 1/2"

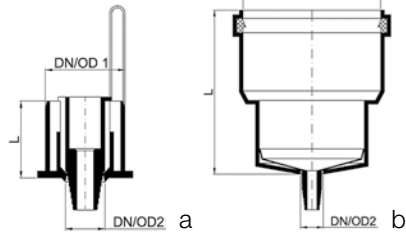

DN/OD1	DN/OD2	Item No.	Typ	L	kg/pc.
40	1/2"	02357	a	39	0.03
50	1/2"	02358	a	39	0.04
110*	1/2"	02387	b	131	0.25

## POLO-KAL NG Condensate discharge for flexible hoses DN 100 PKKO connection to 1/2"

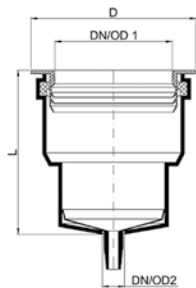

DN/OD1	DN/OD2	Item No.	L1	kg/pc.
100	1/2"	02388	134	0.34

## POLO-KAL NG Siphon fitting PKS with push-fit seal\*

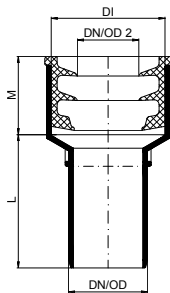

DN/OD1	DN/OD2		Item No.	L	M	DI	kg/pc.
32	5/4"	32 mm	02350	54	32	46	0.05
40	5/4"	40 mm	02351	54	32	46	0.05
40	6/4"	40 mm	02352	54	32	46	0.04
50	5/4"	32 mm	02353	48	38	46	0.05
50	6/4"	40 mm	02354	48	38	46	0.04
50	2"	50 mm	02355	60	29	67	0.08

## POLO-KAL NG Siphon bend PKSW with push-fit seal\*

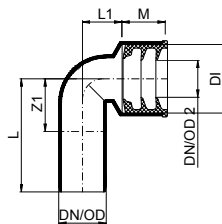

DN/OD1	DN/OD2		Item No.	L	Z1	L1	M	DI	kg/pc.
32	5/4"	32 mm	02360	76	36	27	31	46	0.05
40	5/4"	32 mm	02361	79	34	28	31	46	0.06
40	6/4"	40 mm	02362	79	34	29	29	46	0.05
50	5/4"	32 mm	02363	88	41	30	30	46	0.07
50	6/4"	40 mm	02364	88	41	34	26	46	0.06
50	2"	50 mm	02365	89	42	35	29	67	0.09

\* Push-fit seal provided, unassembled

Subject to technical alterations

# PIPE SYSTEMS

Dimensions in mm

STANDARDS, APPROVALS  
AND TESTS

PIPE SYSTEMS

FIRE PROTECTION

SOUND PROTECTION

PIPE INSULATION

PIPE SYSTEM - LAYING  
INSTRUCTIONS

TEXTS FOR TENDERS

POLO-KAL NG Siphon bend, long, reduced PKSBR with push-fit seal*	DN/OD1	DN/OD2		Item No.	L1	L2	kg/pc.
	50	1 1/4"	32 mm	02250	203	160	0.15
	50	1 1/2"	40 mm	02251	203	160	0.14

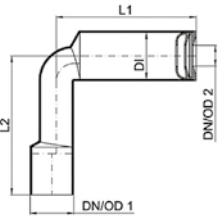

POLO-KAL NG Siphon bend, long PKSB with push-fit seal*	DN/OD1	DN/OD2		Item No.	L1	L2	kg/pc.
	50	2"	50 mm	02252	203	160	0.19

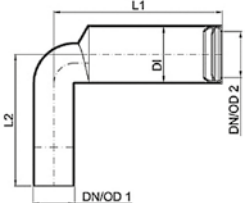

POLO-KAL NG Push-fit seal PKNI	DN/OD		Item No.	DA	kg/pc.
	5/4"	32 mm	01552	47	0.02
	6/4"	32 mm	01553	47	0.01
	2"	50 mm	02380	67	0.04

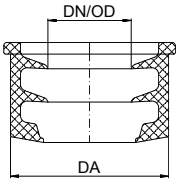

POLO-KAL NG Push-fit seal Old PKNI	DN/OD		Item No.	DA	kg/pc.
	5/4"	32 mm	02378	54	0.04
	6/4"	32 mm	02379	54	0.03

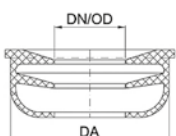

\* Push-fit seal provided, unassembled  
Subject to technical alterations

# PIPE SYSTEMS

Dimensions in mm

STANDARDS, APPROVALS  
AND TESTS

PIPE SYSTEMS

FIRE PROTECTION

SOUND PROTECTION

PIPE INSULATION

PIPE SYSTEM – LAYING  
INSTRUCTIONS

TEXTS FOR TENDERS

## POLO-KAL NG WC transition PKG with seal

DN/OD	Item No.	DI	L	t	kg/pc.
110	02371	115	185	105	0.55



## POLO-KAL NG WC connection PKGB with seal

DN/OD	Item No.	$\alpha$	DI	L	t	Z1	Z2	kg/pc.
110	02372	87.5°	115	129	134	69	65	0.55

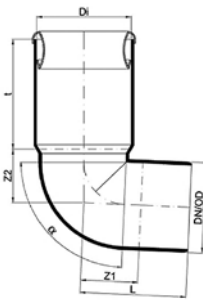

## POLO-KAL NG WC branch PKGA with seal

DN/OD1	DN/OD2	Item No.	$\alpha$	DI	L	t	Z1	Z2	Z3	kg/pc.
110	50	02373	87.5°	115	135	105	39	38	62	0.37

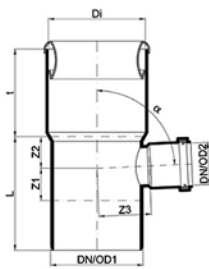

## POLO-KAL NG WC seal PKGD

DN/OD1	DN/OD2	Item No.	DA	L	kg/pc.
110	100	02376	126	46	0.07

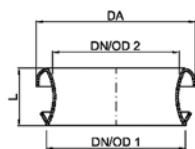

Subject to technical alterations



# PIPE SYSTEMS

Dimensions in mm

## POLO-KAL NG Shift-on ventilating pipe PKDH with adjustable collar

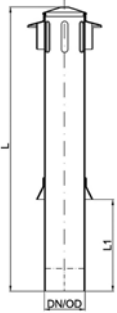

DN/OD	Item No.	L1	L	kg/pc.
110	02384	variable	775	1.12
125	02385	variable	1063	1.85
160	02386	variable	1175	2.79

## POLO-KAL NG Replacement lip ring PKLI

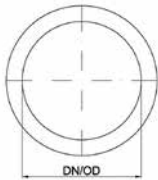

DN/OD	Item No.	kg/pc.
32	02930	0.00
40	02931	0.01
50	02932	0.01
75	02933	0.01
90	02929	0.01
110	02934	0.02
125	02935	0.02
160	02936	0.05
200	02937	0.07
250	02938	0.18

## POLO-KAL NG Lip ring NBR PKNL

oil and grease resistant. impervious to radon

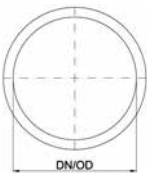

DN/OD	Item No.	kg/pc.
50	00149	0.00
75	00150	0.01
90	00151	0.01
110	00152	0.02
125	00153	0.03
160	00154	0.05
200	00155	0.07
250	00156	0.18

## POLO-KAL NG Replacement double lip ring PKDL

for slip-on sleeve

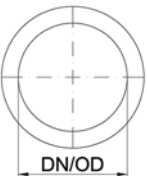

DN/OD	Item No.	kg/pc.
40	02940	0.01
50	02941	0.01
75	02942	0.01
90	02946	0.01
110	02943	0.02
125	02944	0.03
160	02945	0.04
200	02947	0.07

STANDARDS, APPROVALS  
AND TESTS

PIPE SYSTEMS

FIRE PROTECTION

SOUND PROTECTION

PIPE INSULATION

PIPE SYSTEM - LAYING  
INSTRUCTIONS

TEXTS FOR TENDERS

## POLO-KAL NG Lip ring Silicone PKLISB

high temperature resistant

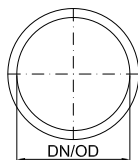

DN/OD	Item No.	kg/pc.
50	00170	0.01
75	00171	0.02
90	00172	0.03
110	00173	0.03
125	00174	0.05
160	00175	0.08

## 2.2.3 POLO-KAL NG ASV – Extraction-proof connection

### 2.2.3.1 Fields of application

In combination with the POLO-KAL NG ASV extraction-proof connection, POLO-KAL NG, which has been approved as pressureless building drainage system, allows the absorption of intermittent dynamic strain, caused by excess pressure, low pressure, and/or vibration.

POLO-KAL NG ASV must be used exclusively in combination with the POLO-KAL NG pipe system.

**The POLO-KAL NG ASV extraction-proof connection opens up new fields of application for the POLO-KAL NG pipe system:**

- **as pressure line for water raising systems** using POLO-KAL NG pipes and bends of the dimensions DN/OD 32 to DN/OD 90.  
Maximum pressure surges must be established in advance through communication with the equipment manufacturer and must be taken into consideration with regard to the maximum admissible pressure load.
- **as pipeline for siphonic roof drainage** POLO-UDS.  
Allows the reliable drainage of high rain yields through pipes with economical cross sections.
- **for interior downpipes** to ensure safety conforming to standards in the case of a backwater level of up to 20 m.
- **to secure socket plugs**  
Prior to the assembly of the POLO-KAL NG ASV, the plug must be pulled out of the socket by 10 mm.
- for exposed pipework in **areas at risk of backwater**, which may be subject to increased pressure loads.
- **to secure against the elements sliding apart** due to mechanical loads.

Subject to technical alterations

# PIPE SYSTEMS

## 2.2.3.2 Product range

Dimensions in mm

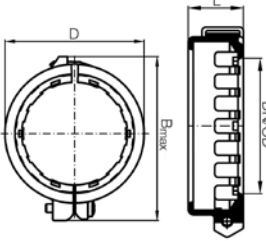
POLO-KAL NG ASV		DN/OD	Item No.	L	D	B-max	max. admissible extraction force in kg	max. admissible pressure load in bar	kg/pc.
		32	01750	21	50	63	100	2.5	0.03
		40	01751	24	61	73	100	2.5	0.04
		50	01752	28	76	92	100	2.5	0.05
		75	01753	30	99	116	130	2.5	0.06
		90	01754	32	115	132	130	2.0	0.11
		110	01755	37	138	153	180	2.0	0.15
		125	01756	39	158	196	440	2.0	0.23
		160	01757	43	197	234	550	2.0	0.30
		200	01758	67	243	281	650	1.5	0.53
		250	01759	87	306	345	650	1.0	0.93

## 2.2.3.3 Advantages of POLO-KAL NG ASV

- Reinforces the secure retention of push-fit connections under increased loads and facilitates new areas of application
- Simple and fast assembly, cost-effective option
- Effortless assembly and disassembly
- The extraction retainer as well as the pipe connections can be released if required

## 2.2.3.4 Assembly of POLO-KAL NG ASV DN/OD 32–250 mm



Before fitting the POLO-KAL NG ASV over the socket, disassemble it. (FIGURE 1)



Fit the half shells together over the socket connection. (FIGURE 2)



Now tighten the screw. The maximum admissible torque is 7 Nm. Fittings in the dimensions DN/OD 32–90 must be pulled apart by 5 mm before the POLO-KAL NG ASV is installed. (FIGURE 3)



Brackets with dimensions equalling DN/OD 90 or larger are equipped with 2 screws. The maximum admissible torque is 7 Nm. (FIGURE 4)

Subject to technical alterations

STANDARDS, APPROVALS AND TESTS

PIPE SYSTEMS

FIRE PROTECTION

SOUND PROTECTION

PIPE INSULATION

PIPE SYSTEM – LAYING INSTRUCTIONS

TEXTS FOR TENDERS

# PIPE SYSTEMS

## 2.2.3.5 Connection to raising systems or immersion pumps

POLO-KAL NG ASV in connection with POLO-KAL NG is suitable to be used in raising systems, as well as for connections to pumps with dimensions up to DN/OD 90 mm. A vibration isolation device must be fitted in the transition area between the raising system or, respectively, the pump and the pipe. The pipe must be fastened with suitable pipe clamps according to the laying instructions. The use of POLO-KAL NG ASV in no way compensates for expert fastening of the pipe. The maximum admissible pump pressure must be established in advance through communication with the equipment manufacturer. The maximum admissible pressure load of POLO-KAL NG ASV must not be exceeded.

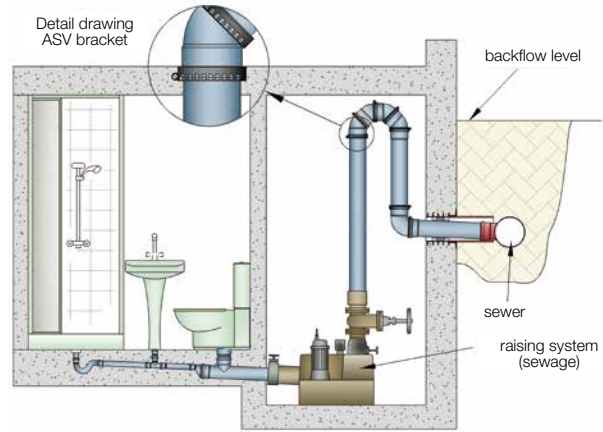

Raising system, faecal matter/waste water (FIGURE 5)

### 2.2.3.5.1 Extract from DIN 1986-100

Backpressure in sewage systems can have numerous causes that are stated in detail in EN 12056-4; these possible causes must be taken into consideration as early as at the stage of planning and installation of the plot drainage system in order to provide proper operation later on. The aim of the normative definitions established in sections 13 and 14 is to prevent buildings and plots from being flooded. Measures preventing backpressure from the sewage system, such as waste-water raising plants or, under certain circumstances, anti-flooding valves, need to be taken into consideration during planning.

Waste water that collects above the backpressure plane has to be gravity-drained into the sewage system. If no sufficient gradient to the sewage system exists, the waste water must be led into the sewage via waste water raising systems; in this case laying requirements according to EN 12056-4 apply.

### 2.2.3.5.2 Product range

Dimensions in mm

**POLO-KAL NG Adaptor union**  
with screw nut, with long spigot

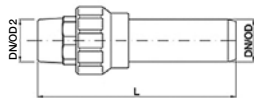

DN/OD	Item No.	DN/OD 2	L	kg/pc.
32	01732	1"	184	0.22
40	01734	1 1/4"	125	0.33
50	01737	1 1/2"	179	0.45

**POLO-KAL NG Adaptor union**  
with external screw thread, with long spigot

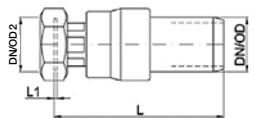

DN/OD	Item No.	DN/OD 2	L	kg/pc.
32	01733	1"	194	0.29
40	01735	1 1/4"	189	0.45
50	01736	1 1/2"	189	0.51

Subject to technical alterations

# PIPE SYSTEMS

Dimensions in mm

STANDARDS, APPROVALS  
AND TESTS

PIPE SYSTEMS

FIRE PROTECTION

SOUND PROTECTION

PIPE INSULATION

PIPE SYSTEM - LAYING  
INSTRUCTIONS

TEXTS FOR TENDERS

## POLO-KAL NG Adaptor union decoupled with external screw thread, with long spigot

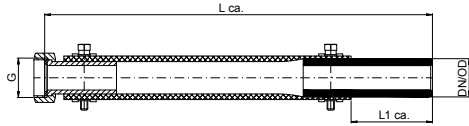

DN/OD	Item No.	G	L	L1	kg/pc.
32	01843	1"	324	68	0,49
40	01844	5/4"	333	70	0,73
50	01845	6/4"	337	70	0,90

## POLO-KAL NG Adaptor union decoupled with external screw thread, with long spigot

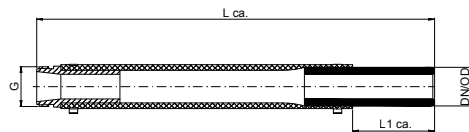

DN/OD	Item No.	G	L	L1	kg/pc.
32	01840	1"	330	68	0,36
40	01841	5/4"	334	67	0,57
50	01842	6/4"	334	68	0,73

## POLO-KAL NG Flange sleeve including seal, with long spigot

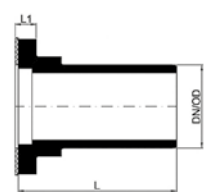

DN/OD	Item No.	L	L1	kg/pc.
75	01740	143	19	0,36
90	01742	146	19	0,49

## POLO-KAL NG Lapped flange for flange sleeve

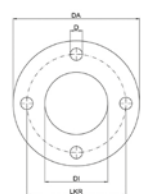

DN/OD	Item No.	DA	DI	LKR	D	AL	kg/pc.
75	01741	185	93	145	18	4	1,15
90	01743	202	106	160	18	8	1,20

# PIPE SYSTEMS

## 2.3 POLO-KAL 3S

### 2.3.1 Technical data

<b>Material</b>	<b>Pipe:</b> PP/PP-MV/PP; <b>Fitting:</b> PP-MV free of halogen and cadmium, free of heavy metals
<b>Colour</b>	Light grey RAL 7035
<b>Resistance to hot water</b>	Short-term 97 °C                      30 sec/day = 152 h/50 years Long-term 95 °C                      10 min/day = 3,000 h/50 years Long-term 60 °C                      5 h/day = 87,600 h/50 years
<b>Application category</b>	B (building) approved for gravity drainage systems inside buildings in accordance with EN 1451-1
<b>Pipe marking</b>	Domestic waste disposal pipes of POLO-KAL 3S denomination are marked in the following way: charge number, year and week of manufacture, company name, dimension and certification marking.
<b>Chemical resistance</b>	Pipes and fittings made of PP – according to DIN 8078, supplement 1 Seals made of SBR – according to ISO TR7620
<b>Connections</b>	Push-fit sockets with factory-inserted lip seals. Seal material = SBR
<b>Fire behaviour</b>	According DIN 4102: B2, Q2, TR1 According EN 13501-1: D-s2, d1
<b>Ring rigidity</b>	The ring rigidity value of POLO-KAL 3S pipes is above 4 kN/m <sup>2</sup> .
<b>E-modulus</b>	1000 MPa according to ISO 178
<b>Leakproofness</b>	According to EN 1451-1, test report ÖKI 25.764
<b>Mean coefficient of elongation LAK</b>	0.09 mm/m K (OFI test report No. 47,423)
<b>Third-party monitoring of product quality</b>	POLO-KAL 3S pipes and fittings are third-party monitored by authorised German and Austrian plastics testing institutes.
<b>Drinking water suitability</b>	POLO-KAL 3S is not approved for the transportation of drinking water.

Subject to technical alterations

# PIPE SYSTEMS

## 2.3.2 Product range

All technical data including AutoCAD drawings can be found on the POLOPLAST product catalogue.

Dimensions in mm

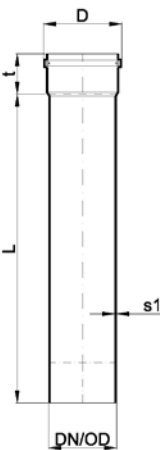
POLO-KAL 3S Socket pipe PKSEM with factory-fitted lip ring	DN/OD*	Item No.	L	s1(min)	t(min)	D(max)	kg/pc.
		75	02420	150	3.8	52	91
	75	02421	250	3.8	52	91	0.30
	75	02422	500	3.8	52	91	0.60
	75	02423	1000	3.8	52	91	1.19
	75	02424	1500	3.8	52	91	1.79
	75	02425	2000	3.8	52	91	2.39
	75	02426	3000	3.8	52	91	3.58
	90	02410	150	4.5	54	107	0.26
	90	02411	250	4.5	54	107	0.44
	90	02412	500	4.5	54	107	0.87
	90	02413	1000	4.5	54	107	1.75
	90	02414	1500	4.5	54	107	2.62
	90	02415	2000	4.5	54	107	3.49
	90	02416	3000	4.5	54	107	5.24
	110	02430	150	4.8	59	129	0.34
	110	02431	250	4.8	59	129	0.56
	110	02432	500	4.8	59	129	1.12
	110	02433	1000	4.8	59	129	2.24
	110	02434	1500	4.8	59	129	3.36
	110	02435	2000	4.8	59	129	4.48
	110	02436	3000	4.8	59	129	6.72
	125	02471	250	5.3	63	148	0.74
	125	02472	500	5.3	63	148	1.48
	125	02473	1000	5.3	63	148	2.97
	125	02474	1500	5.3	63	148	4.45
	125	02475	2000	5.3	63	148	5.93
	125	02476	3000	5.3	63	148	8.90
	160	02451	250	7.5	70	187	1.28
	160	02452	500	7.5	70	187	2.56
	160	02453	1000	7.5	70	187	5.11
	160	02455	2000	7.5	70	187	10.23
	160	02456	3000	7.5	70	187	15.34

STANDARDS, APPROVALS  
AND TESTS

PIPE SYSTEMS

FIRE PROTECTION

SOUND PROTECTION

PIPE INSULATION

PIPE SYSTEM - LAYING  
INSTRUCTIONS

TEXTS FOR TENDERS

\* DN/OD – according to European standardisation CEN/TC 155: Dimension Nominal / Outside Diameter

Subject to technical alterations

# PIPE SYSTEMS

Dimensions in mm

STANDARDS, APPROVALS  
AND TESTS

PIPE SYSTEMS

FIRE PROTECTION

SOUND PROTECTION

PIPE INSULATION

PIPE SYSTEM - LAYING  
INSTRUCTIONS

TEXTS FOR TENDERS

## POLO-KAL 3S Bend PKSB

with factory-fitted lip ring

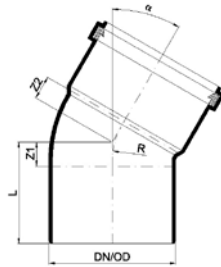

	DN/OD	Item No.	Z1	Z2	R	L	kg/pc.
15°	75	02520	7	10	46	55	0.26
	90	02526	20	13	41	71	0.36
	110	02530	9	11	57	64	0.48
	125	02560	11	13	90	85	0.48
	160	02550	13	16	115	98	0.87
30°	75	02521	13	16	46	62	0.28
	90	02527	26	18	41	77	0.38
	110	02531	17	19	57	72	0.53
	125	02561	19	22	90	92	0.52
	160	02551	22	26	115	108	1.04
45°	75	02522	19	23	46	68	0.30
	90	02528	31	25	41	82	0.41
	110	02532	25	27	57	80	0.59
	125	02562	30	31	90	104	0.57
	160	02552	37	41	115	122	1.10
67.5°	75	02523	31	34	46	80	0.34
	110	02533	40	41	57	96	0.65
87.5°	75	02525	44	48	46	93	0.37
	90	02529	58	49	41	109	0.51
	110	02535	56	58	57	111	0.78
	125	02565	64	67	90	138	0.62
	160	02555	84	87	115	169	1.35

## POLO-KAL 3S Branch PKSA

with factory-fitted lip ring

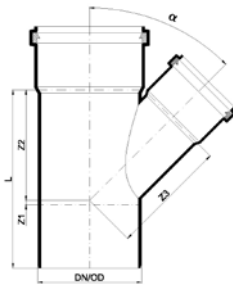

	DN/OD	Item No.	Z1	Z2	Z3	L	kg/pc.
45°	75/50	02643	8	87	89	144	0.54
	75/75	02606	20	106	104	175	0.67
	90/50	02644	5	93	98	149	0.60
	90/75	02605	53	149	152	256	0.72
	90/90	02607	33	123	123	207	0.93
	110/50	02646	-7	106	116	154	0.84
	110/75	02649	14	123	128	192	1.02
	110/90	02653	28	165	171	253	0.99
	110/110	02609	25	149	148	229	1.35
	125/110	02568	30	163	167	267	1.12
	125/125	02566	29	165	164	268	1.27
	160/110	02657	0	176	198	262	1.66
	160/160	02615	33	214	211	332	2.41
67.5°	110/50	02647	20	60	79	135	0.78
	110/75	02650	35	74	83	164	0.90
	110/110	02610	40	92	95	188	1.05

Subject to technical alterations



# PIPE SYSTEMS

Dimensions in mm

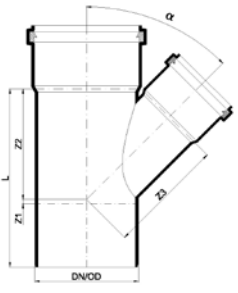
<b>POLO-KAL 3S Branch PKSA</b> with factory-fitted lip ring	87.5°	DN/OD	Item No.	Z1	Z2	Z3	L	kg/pc.
			75/50	02645	30	35	44	114
	75/75	02608	44	48	48	141	0.51	
	90/50	02603	59	55	74	165	0.85	
	90/75	02604	66	69	74	189	0.57	
	90/90	02613	59	55	56	165	0.72	
	110/50	02648	43	38	69	137	0.73	
	110/75	02651	56	51	69	162	0.84	
	110/90	02652	114	77	86	201	0.79	
	110/110	02611	70	66	67	191	1.07	
	125/110	02569	66	76	86	216	0.92	
	125/125	02567	66	77	75	216	0.99	
	160/110	02659	83	92	115	261	1.59	
	160/160	02660	107	133	124	310	2.68	

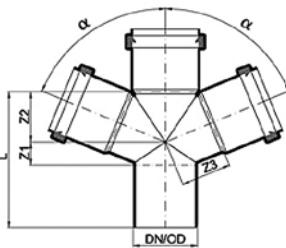
<b>POLO-KAL 3S Double branch PKSDA</b> with factory-fitted lip ring	DN/OD	Item No.	$\alpha$	Z1	Z2	Z3	Z4	L	kg/pc.
		110/110/110	02695	45°	24	145	146	137	225
	110/110/110	02513	67.5°	39	91	93	-	186	1.40
	110/110/110	02694	87.5°	70	66	67	73	191	1.26

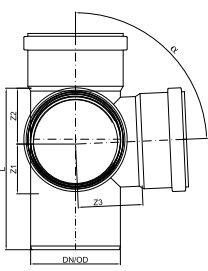
<b>POLO-KAL 3S Double corner branch PKSEDA</b> with factory-fitted lip ring	DN/OD	Item No.	Z1	Z2	Z3	Z4	L	kg/pc.
		110/110/110	02674	70	66	67	86	191

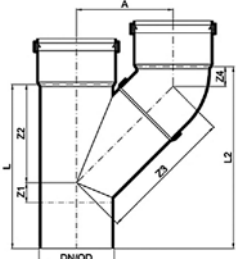
<b>POLO-KAL 3S Parallel branch PKSPA</b> with factory-fitted lip ring	DN/OD	Item No.	L	L2	Z1	Z2	Z3	A	kg/pc.
		110	02684	229	249	25	149	194	142

Subject to technical alterations

STANDARDS, APPROVALS AND TESTS

PIPE SYSTEMS

FIRE PROTECTION

SOUND PROTECTION

PIPE INSULATION

PIPE SYSTEM - LAYING INSTRUCTIONS

TEXTS FOR TENDERS

# PIPE SYSTEMS

Dimensions in mm

STANDARDS, APPROVALS  
AND TESTS

PIPE SYSTEMS

FIRE PROTECTION

SOUND PROTECTION

PIPE INSULATION

PIPE SYSTEM – LAYING  
INSTRUCTIONS

TEXTS FOR TENDERS

## POLO-KAL 3S Reducer PKSR

with factory-fitted lip ring

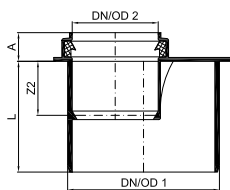
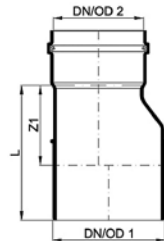

\* short version

DN/OD1	DN/OD2	Item No.	Z1	Z2	A	L	kg/pc.
75	50	02738	23	-	-	75	0.24
90	50	02739*	-	32	17	66	0.15
90	75	02740*	-	37	17	61	0.13
110	50	02742	41	-	-	100	0.38
110	75	02743	26	-	-	84	0.40
110	90	02741*	-	40	20	66	0.21
125	110	02570	30	-	-	92	0.40
160	110	02745	70	-	-	140	0.66
160	125	02747	44	-	-	114	0.70

## POLO-KAL 3S Cleaning pipe PKSRE

with factory-fitted lip ring,  
pressure-sealed up to 0.5 bar

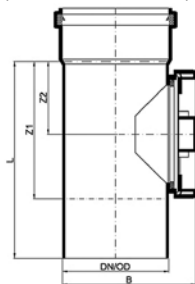

DN/OD	Item No.	Z1	Z2	B	L	kg/pc.
75	02766	100	52	96	156	0.38
90	02772	93	45	139	150	0.82
110	02773	139	71	142	199	1.12
125	02559	190	90	167	252	1.03
160	02782	185	100	212	255	1.69

## POLO-KAL 3S Sleeve socket PKSU

with factory-fitted double lip ring

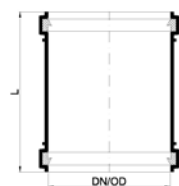

DN/OD	Item No.	L	kg/pc.
75	02712	110	0.26
90	02716	127	0.22
110	02713	120	0.50
125	02571	158	0.51
160	02715	181	0.87

## POLO-KAL 3S Double socket PKSD

with factory-fitted lip ring

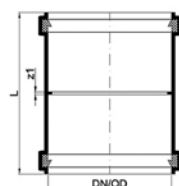

DN/OD	Item No.	Z1	L	kg/pc.
75	02722	3	110	0.28
110	02723	4	120	0.50

Subject to technical alterations

# PIPE SYSTEMS

Dimensions in mm

STANDARDS, APPROVALS  
AND TESTS

PIPE SYSTEMS

FIRE PROTECTION

SOUND PROTECTION

PIPE INSULATION

PIPE SYSTEM - LAYING  
INSTRUCTIONS

TEXTS FOR TENDERS

## POLO-KAL 3S Long sleeve PKSL with factory-fitted double lip ring

DN/OD	Item No.	L	t	D	kg/pc.
110	02700	59	160	131	0.81

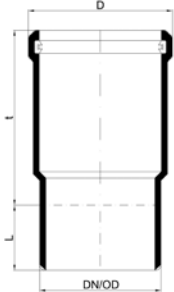

## POLO-KAL 3S Socket plug PKM

DN/OD	Item No.	L	kg/pc.
50	02322	44	0.02
75	02323	51	0.06
90	02327	55	0.09
110	02324	62	0.14
125	02325	81	0.19
160	02326	92	0.36

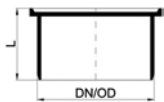

For special components refer to POLO-KAL 3S

## POLO-KAL 3S Replacement lip ring PKSLI

DN/OD	Item No.	kg/pc.
50	02932	0.006
75	02933	0.010
90	02929	0.014
110	02934	0.019
125	02935	0.020
160	02936	0.046

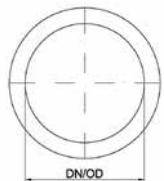

## POLO-KAL 3S lip ring NBR PKNL

oil and grease resistant, impervious to radon

DN/OD	Item No.	kg/pc.
50	00149	0.004
75	00150	0.010
90	00151	0.012
110	00152	0.020
125	00153	0.028
160	00154	0.050

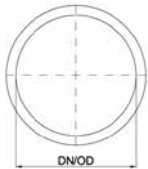

## POLO-KAL 3S Replacement double lip ring PKDL

for slip-on sleeve

DN/OD	Item No.	kg/pc.
75	02942	0.009
90	02946	0.013
110	02943	0.024
125	02944	0.027
160	02945	0.043



Subject to technical alterations

# PIPE SYSTEMS

## POLO-KAL NG Replacement double lip ring PKDL for slip-on sleeve and long sleeve sockets

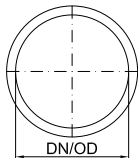

DN/OD	Item No.	kg/pc.
50	00170	0.01
75	00171	0.02
90	00172	0.03
110	00173	0.03
125	00174	0.05
160	00175	0.08

## 2.4 Connections to pipe systems made of other materials

POLOPLAST provide specially developed transition fittings to connect POLO-KAL pipes to pipe systems made of other materials.

**NOTE:** Make sure to fit pipe elements free from distortion. The floating ring seal should be evenly pressed. When laid free from distortion, the transition fittings are leakproof up to 0.3 bar.

### Connection to fibre cement pipes

Dimensions in mm

#### Connection from POLO-KAL NG spigot end to fibre cement socket PKUMAG

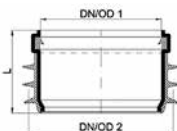

DN/OD1	DN/OD2	Item No.	L	kg/pc.
50	75–83	02860	98	0.09
75	96–104	02861	63	0.14
110	129–138	02862	76	0.24
125	151–161	02863	88	0.46
160	182–189	02864	98	0.53

#### Connection from POLO-KAL NG spigot end to fibre cement spigot end PKUSAG

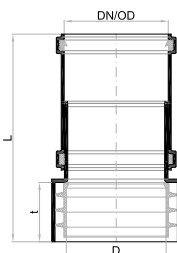

DN/OD	Item No.	D	L	t	kg/pc.
50	02870	58–67	164	44	0.18
75	02871	78–86	108	49	0.33
110	02872	110–116	221	63	0.63
125	02873	135–142	208	73	0.99
160	02874	160–172	216	77	1.45

#### Connection from fibre cement spigot end to POLO-KAL socket PKULSAG

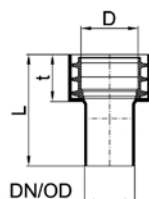

DN/OD	Item No.	D	L	t	kg/pc.
50	02850	58–67	112	47	0.12
75	02851	78–86	121	49	0.19
110	02852	110–116	147	63	0.35
125	02853	135–142	312	74	0.59
160	02854	160–172	355	77	0.75

Subject to technical alterations

# PIPE SYSTEMS

## Connection to cast iron pipes

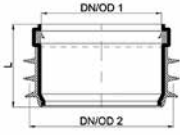
Connection from POLO-KAL NG spigot end to cast iron socket PKUMAG		DN/OD1	DN/OD2	Item No.	L	kg/pc.
		50	75–83	02860	98	0.09
		75	96–104	02861	63	0.14
		125	151–161	02863	88	0.46

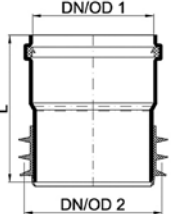
Connection from POLO-KAL NG spigot end to cast iron socket PKUMAG		DN/OD1	DN/OD2	Item No.	L	kg/pc.
		110	120–131	02865	135	0.32
		160	176–179	02867	165	0.73

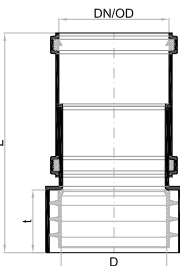
Connection from POLO-KAL NG spigot end to cast iron spigot end PKUSAG		DN/OD	Item No.	D	L	t	kg/pc.
		50	02870	58–67	164	44	0.176
		75	02871	78–86	178	53	0.22
		110	02872	110–116	221	63	0.63
		125	02873	135–142	208	69	0.99
		160	02874	160–172	216	77	1.45

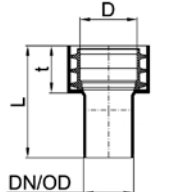
Connection from cast iron spigot end to POLO-KAL NG socket PKULSAG		DN/OD	Item No.	D	L	t	kg/pc.
		50	02850	58–67	112	47	0.12
		75	02851	78–86	121	49	0.19
		110	02852	110–116	147	63	0.35
		125	02853	135–142	312	74	0.59
		160	02854	160–172	355	77	0.75

STANDARDS, APPROVALS  
AND TESTS

PIPE SYSTEMS

FIRE PROTECTION

SOUND PROTECTION

PIPE INSULATION

PIPE SYSTEM - LAYING  
INSTRUCTIONS

TEXTS FOR TENDERS

# PIPE SYSTEMS

STANDARDS, APPROVALS  
AND TESTS

PIPE SYSTEMS

FIRE PROTECTION

SOUND PROTECTION

PIPE INSULATION

PIPE SYSTEM – LAYING  
INSTRUCTIONS

TEXTS FOR TENDERS

## Connection to POLO-KAL pipes “Generation before 1960”

Dimensions in mm

**Connection from POLO-KAL NG spigot end to POLO-KAL NG socket “Generation before 1960” PKUMA**

DN/OD1	DN/OD2	Item No.	L	t	kg/pc.
50	54	02880	114	47	0.05
110	100	02881	190	67	0.29

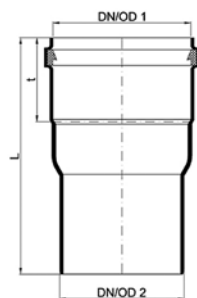

**Connection from POLO-KAL NG socket to DN 100 spigot end**

DN/OD1	DN/OD2	Item No.	L	kg/pc.
100	110	02389	34	0.09

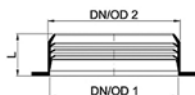

## Replacement seals

**Seal for connections to fibre cement or cast iron pipes PKUDGA**

Colour: black

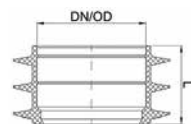

DN/OD	Item No.	L	kg/pc.
50	02890	41	0.05
75	02891	43	0.07
110	02892	58	0.09
125	02893 *)	64	0.20
125	02895 **)	64	0.18
160	02894	70	0.16

\*) to be slipped on outer diameters from 135–142 mm

\*\*\*) to be slipped on outer diameters 125–130 mm (“old generation”)

Subject to technical alterations

# PIPE SYSTEMS

## Connection to stoneware

Dimensions in mm

**Connection from POLO-KAL NG spigot end to stoneware socket with roll ring PKUSM**

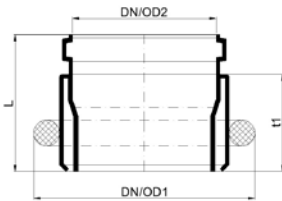

DN/OD1	DN/OD2	Item No.	L	t1	kg/pc.
stoneware socket	110	01720	106	75	0.45
stoneware socket	125	01721	108	75	0.62
stoneware socket	160	01722	112	75	0.84
stoneware socket	200	01723	244	75	2.33

**Connection from stoneware spigot end to POLO-KAL NG socket with profile ring PKUS**

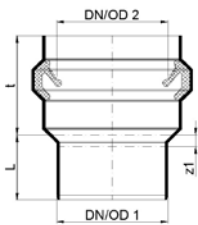

DN/OD1	DN/OD2	Item No.	L	t	Z1	kg/pc.
110 spigot end	128–134	01725	70	107	12	0.48
125 spigot end	155–162	01726	81	127	16	0.75
160 spigot end	182–190	01727	94	142	17	1.29
200 spigot end	237–247	01728	159	166	37	2.34

STANDARDS, APPROVALS  
AND TESTS

PIPE SYSTEMS

FIRE PROTECTION

SOUND PROTECTION

PIPE INSULATION

PIPE SYSTEM - LAYING  
INSTRUCTIONS

TEXTS FOR TENDERS

# PIPE SYSTEMS

## 2.5 POLO-EHP control

With its large cleaning aperture, POLO-EHP control offers a sensible solution for maintenance, inspection and cleaning – a practical complement for the POLO-KAL NG and POLO-KAL 3S assortments.

### 2.5.1 Easy maintenance and cleaning

- **Simple and secure locking mechanism**
  - can be opened easily and without tools
  - free of metallic screw joints
  - reliable and leakproof when re-fastened
- **Normalised size of top-opening**  
in compliance with the requirements of EN 13598-1 and ÖNORM B2501
- **High internal pressure tightness**  
long-term tight up to 1.0 bar, short term up to 1.5 bar
- **Pressure release when unlocking**  
for safe handling
- **Constant cross section of discharge flow**  
no change of cross section, therefore no danger of obstruction
- **System- and material-compatible – free of halogen**
- **Big cleaning aperture**  
suitable for camera inspection and high pressure flushing



### 2.5.2 Standard requirements

The cleaning pipe POLO-EHP control meets all standard requirements of EN 12056, EN 13598-1 and DIN 1986-100:

POLO-EHP control	Meets requirements
no change of cross section, therefore no danger of obstruction	✓
suitable for camera inspection and high pressure flushing	✓
long-term tight up to 1.0 bar, short term up to 1.5 bar	✓
guaranteed long-term unlocking and locking without tools; no screw-joints, therefore free of corrosion	✓



# PIPE SYSTEMS

## 2.5.3 Product range

POLO-EHP control . Cleaning pipe for POLO-KAL NG, POLO-KAL 3S, POLO-UDS

Dimensions in mm

POLO-EHP control in blue for POLO-KAL NG PKEHP	DN/OD	Item No. PL	L	s1(min)	t socket	D	H	L1	kg/pc.
	110	01900	468	3.6	65	129	196	301	2.3
	125	01901	474	4.0	73	146	222	301	2.5
	160	01902	488	5.1	84	185	251	301	3.2
	200	01903	518	7.0	120	231	295	301	4.6
	250	01904	680	8.6	156	289	330	301	8.5

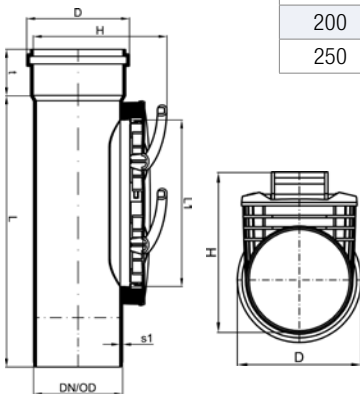

POLO-EHP control in white for POLO-KAL 3S PKEHP	DN/OD	Item No. PL	L	s1(min)	t socket	D	H	L1	kg/pc.
	110	06590	468	3.6	65	129	196	301	2.3
	125	06591	474	4.0	73	146	222	301	2.5
	160	06592	488	5.1	84	185	251	301	3.2

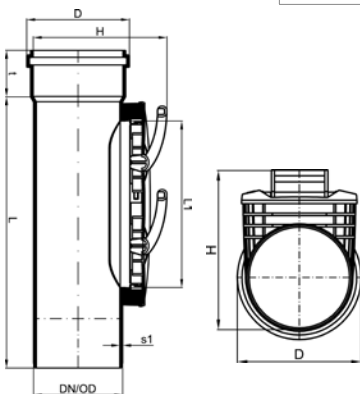

Material: Polypropylene (PP)

Subject to technical alterations

# PIPE SYSTEMS

## 2.6 Pipe fastening elements

### 2.6.1 POLO-CLIP HS

#### 2.6.1.1 Description of the system

The POLO-CLIP HS pipe clamp is a fastening system for three nominal pipe diameters, DN/OD 110, 90 and 75, which provides a high level of sound insulation. The bracket base, its ribs, and the lock have a specially designed shape.



- The base of the clamp is reinforced with a M8 or M10 nut
- Slanted ribs made of technical elastomer optimally adjusted to building drainage pipes in accordance with EN 1451-1
- No-tool locking mechanism due to simple clip system for reliable and optimal retention of the pipe
- Ideal locking forces guarantee perfect acoustic decoupling

#### 2.6.1.2 Product range

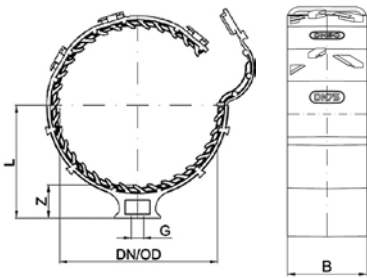

Dimensions in mm

for DN/OD	Item No.	L	G	B	kg/pc.
75	01851	78	M8	50	0.12
90	01851	78	M8	50	0.12
110	01851	78	M8	50	0.12
75	01854	78	M10	50	0.12
90	01854	78	M10	50	0.12
110	01854	78	M10	50	0.12

POLO-CLIP HS (FIGURE 6)

#### 2.6.1.3 Maximum working load

for DN/OD	max. pipe weight*) kg/m	max. working load of the pipe clamp when ceiling mounted kg	max. working load of the pipe clamp when wall mounted kg
75	4.42	90	60
90	7.46	90	60
110	9.50	90	60

\*) dead weight of the pipe filled with water per running meter

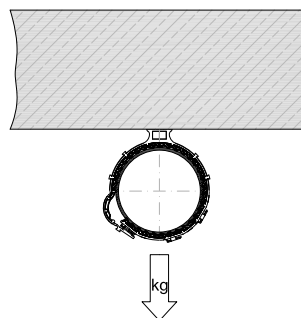

Ceiling mounting  
(FIGURE 7)

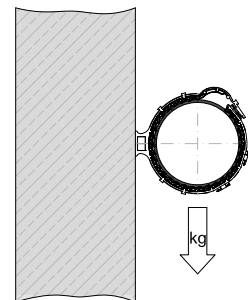

Wall mounting  
(FIGURE 8)

Subject to technical alterations

# PIPE SYSTEMS

## 2.6.2 POLO-CLIP

### 2.6.2.1 Product range

Dimensions in mm

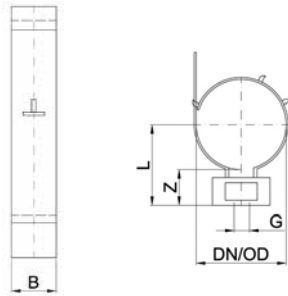

POLO-CLIP (FIGURE 9)

for DN/OD	Item No.		L	B	Z	kg/pc.
	colour blue					
	M8	M10				
32	01811	01810	35	25	19	0.03
40	01811	01810	35	25	19	0.03
50	01811	01810	35	25	19	0.03
75	01812	01815	61	25	23	0.04
90	01812	01815	61	25	23	0.04
110	01812	01815	61	25	23	0.04
125	-	01819	86	25	24	0.07
160	-	01819	86	25	24	0.07

### 2.6.2.2 Maximum working load

for DN/OD	max. pipe weight*) kg/m	max. working load of the pipe clamp when ceiling mounted kg	max. working load of the pipe clamp when wall mounted kg
32	0.81	30	20
40	1.28	30	20
50	1.96	30	20
75	4.42	60	50
90	7.46	60	50
110	9.50	60	50
125	12.27	120	100
160	20.11	120	100

\*) dead weight of the pipe filled with water per running meter

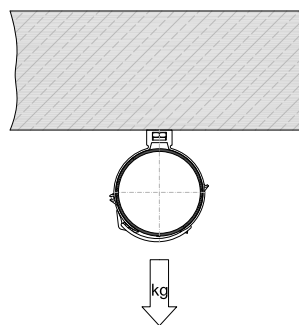

Ceiling mounting  
(FIGURE 10)

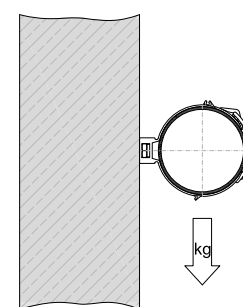

Wall mounting  
(FIGURE 11)

# PIPE SYSTEMS

## 2.6.3 RBT screw clamp

Dimensions in mm

### 2.6.3.1 Product range

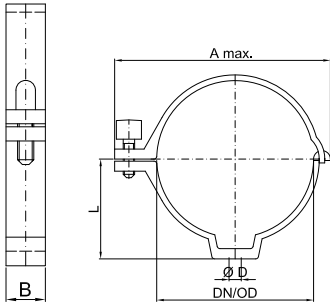

for DN/OD	Item No.	Ø D	A max.	B	L	kg/pc.
40	01930	6	74	20	33	0.03
50	01931	6	85	20	38	0.03
75	01932	6	114	20	50	0.04
110	01933	6	151	20	70	0.05

Dimensioning (FIGURE 12)

## 2.6.4 Fastening set

### 2.6.4.1 Description of the system

The POLOPLAST fastening set allows a variety of fastening options, either direct or noise-insulated.

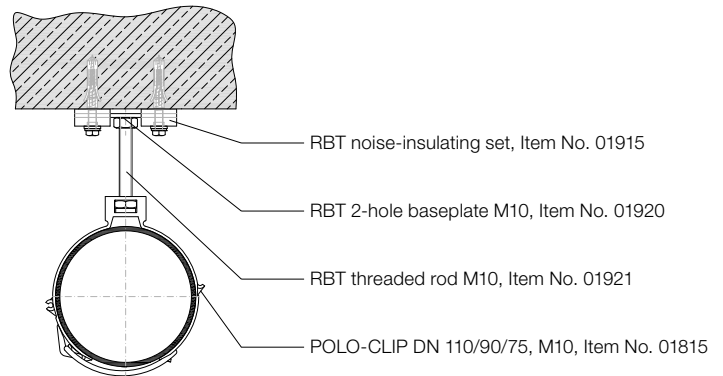

Example of noise-insulated fastening (FIGURE 13)

### 2.6.4.2 Product range



#### RBT noise-insulating set RBSD

comprised of 6/60 slotted zinc-plated frame screw, M 6 flat washer, round noise-insulating element, angular noise-insulating element including one-hole base plate, M 8 high-quality dowel

**Item No.**  
01915



#### RBT 2-hole base plate M 10 RBLP

**Item No.**  
01920



#### RBT threaded rod M 10/1000 RBGS

**Item No.**  
01921

Subject to technical alterations

# FIRE PROTECTION

## 3.1 General information

### 3.1.1 Standards and regulations

#### Europe:

- Construction products directive
- EN 13501-2: classification of construction products and construction types according to their fire behaviour

### 3.1.2 Purpose of fire protection

**Personal protection:** protection of life and health

**Material value protection:** protection of property

**Environmental protection:** avoidance of contaminating air, water and soil

#### A number of measures can be planned in order to achieve these goals:

- Reduction of the hazard of fire breaking out and spreading (including smoke)
- Provision of measures to quickly discover fire
- Provision of suitable, barrier-free escape and rescue paths for individuals

## 3.2 Definitions

### 3.2.1 Fire protection plan

The purpose of a fire protection plan is to prove that the targets of protection have been reached or, in case of deviation, that equivalent targets of protection have been reached.

The fire protection plan describes the individual fire protection measures and their links in relation to the required targets of protection. It therefore contains all comprehensively coordinated structural, technical, organisational and fire-fighting measures.

The fire protection plan must correspond to the individual building and its usage; it is advisable to develop the plan at an early stage of planning.

An individual fire protection plan usually consists of risk assessment, a definition of the relevant targets of protection, as well as a definition of fire hazards, from which specific preventative and fire-fighting measures are derived.

### 3.2.2 Construction products directive

According to the EU construction products directive No. 305/2011, valid as from 01.07.2013, fire protection is one of the most essential requirements with regard to buildings. Its basic requirements stipulate that in case of fire:

- the bearing capacity of the building has to be maintained over a certain period,
- development and proliferation of fire and smoke must be limited within the building,
- spreading of the fire to adjacent buildings must be fought,
- the occupants can leave the building without injuries or can be saved by other measures and the safety of the rescue teams is taken into account.

### 3.2.3 Fire compartments

Fire compartments are sections of buildings that are bordered on all sides by structural elements endowed with a certain degree of fire resistance and/or fire protection zones.

### 3.2.4 Structural elements that form fire compartments

Structural elements that form fire compartments represent the borders of fire compartments. They can be situated in the interior of the building (fire walls) as well as on the border of the property (fire-proof party walls).

# FIRE PROTECTION

## 3.3 Fire protective collar

### 3.3.1 POLO-BSM

#### 3.3.1.1 Fields of application

The POLO-BSM fire protective collar has been tested for fire resistance category EI90 and can be used with the following building drainage pipe programmes:

- POLO-KAL NG of DN/OD 32–250 mm
- POLO-KAL 3S of DN/OD 75–160 mm

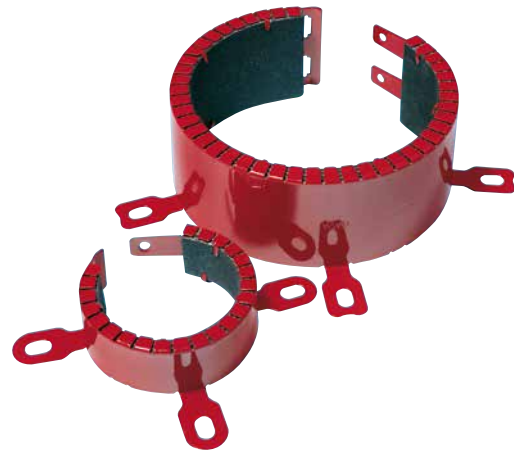

#### 3.3.1.2 Function

When exposed to fire and heat, the plastic pipe becomes malleable and deforms. Simultaneously, at temperatures starting at 150 °C, the special fire protection laminate expands to ten times its volume.

Where expansion possibilities are limited, an expansion pressure of up to 10 bar results and ensures a reliable seal against fire and hot gas between the fire compartments.

Within a few minutes, the fire protection laminate fully squeezes the plastic pipe together and seals off the wall or ceiling opening completely. This makes it impossible for flames and smoke to spread into the adjacent fire compartment through the piping.

#### 3.3.1.3 Tests, approvals

With the POLO-BSM fire protective collar, POLOPLAST offers a system-tested and approved solution for the building drainage pipe systems POLO-KAL NG and POLO-KAL 3S.

POLO-BSM is approved for fire resistance category EI90 – u/u

- DIBt-approved in Germany with the approval number: Z-19.17-1747
- classification according to EN 13501-2: 2007+A1: 2089
- approved according to ETA-15/0686

# FIRE PROTECTION

Any national standards beyond these are to be observed.

Tested in accordance with EN 1366-3 and classified in accordance with EN 13501-2

Installation	DN/OD									
	32	40	50	75	90	110	125	160	200	250
 <p>in solid and light-weight partition walls, over smooth pipe</p>	PK-NG 02813	PK-NG 02814	PK-NG 02815	PK-NG PK-3S 02818	PK-NG PK-3S 02819	PK-NG PK-3S 02820	PK-NG PK-3S 02821	PK-NG PK-3S 02822	PK-NG 02823	PK-NG 02824
 <p>in solid ceilings, fitted over smooth pipe</p>	PK-NG 02813	PK-NG 02814	PK-NG 02815	PK-NG PK-3S 02818	PK-NG PK-3S 02819	PK-NG PK-3S 02820	PK-NG PK-3S 02821	PK-NG PK-3S 02822	PK-NG 02823	PK-NG 02824
 <p>at an angle through solid walls, over smooth pipe</p>	-	-	PK-NG 02806	PK-NG PK-3S 02808	PK-NG PK-3S 02809	PK-NG PK-3S 02811	PK-NG PK-3S 02810	-	-	-
 <p>at an angle through solid ceilings, over smooth pipe</p>	-	-	PK-NG 02806	PK-NG PK-3S 02808	PK-NG PK-3S 02809	PK-NG PK-3S 02811	PK-NG PK-3S 02810	-	-	-
 <p>in solid walls over a socket</p>	-	-	PK-NG 02802	PK-NG PK-3S 02807	PK-NG PK-3S 02808	PK-NG PK-3S 02809	PK-NG PK-3S 02810	-	-	-
 <p>in solid ceilings over a socket</p>	-	-	PK-NG 02802	PK-NG PK-3S 02807	PK-NG PK-3S 02808	PK-NG PK-3S 02809	PK-NG PK-3S 02810	-	-	-
 <p>in solid walls and ceilings, fully bedded in mortar, over a smooth pipe</p>	PK-NG 02813	PK-NG 02814	PK-NG 02815	PK-NG PK-3S 02818	PK-NG PK-3S 02819	PK-NG PK-3S 02820	PK-NG PK-3S 02821	PK-NG PK-3S 02822	PK-NG 02823	PK-NG 02824
 <p>in solid and light-weight partition walls with soft fittings Intumex AC over a smooth pipe</p>	PK-NG 02813	PK-NG 02814	PK-NG 02815	PK-NG PK-3S 02818	PK-NG PK-3S 02819	PK-NG PK-3S 02820	PK-NG PK-3S 02821	PK-NG PK-3S 02822	PK-NG 02823	PK-NG 02824

Further information on the installation situation and the general condition can be found in ETA-Approval ETA-15/0686.

Notes for installation can be found in the assembly manual.

Subject to technical alterations



# FIRE PROTECTION

## 3.3.2 Product range

Dimensions in mm

### POLO-BSM Set

Accessories

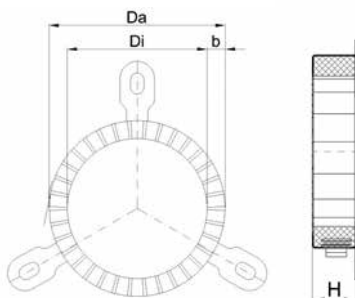

Item No.	H	b	Di	Da	Brackets	kg/pc.
02802	60	8	73	89	3	0.20
02806	60	10	85	106	3	0.27
02807	60	11	100	122	3	0.38
02808	60	11	120	142	4	0.44
02809	60	11	135	157	4	0.48
02810	60	16	170	202	5	0.81
02811	60	14	150	177	5	0.63
02813	30	9	35	53	2	0.05
02814	30	8	45	61	2	0.07
02815	30	8	60	76	3	0.09
02818	30	11	85	106	3	0.14
02819	30	11	100	122	3	0.21
02820	30	11	120	142	4	0.23
02821	30	11	135	157	4	0.26
02822	30	16	170	202	5	0.43
02823	60	16	210	242	5	0.95
02824	60	26	260	312	6	1.82

The POLO-BSM set is made up of the following components:

- fire protective collar
- fastening set for solid wall/ceiling
- noise-insulating interlayer
- installation instructions including declaration of compliance
- designation plate

This complete set allows a simple and secure assembly without the need for any additional materials.



STANDARDS, APPROVALS  
AND TESTS

PIPE SYSTEMS

FIRE PROTECTION

SOUND PROTECTION

PIPE INSULATION

PIPE SYSTEM - LAYING  
INSTRUCTIONS

TEXTS FOR TENDERS

# SOUND PROTECTION

## 4.1 General information

Sound perception is highly subjective and is determined by the following factors:

- **Frequency (pitch)**  
Low frequencies are perceived as low sounds, high frequencies as high sounds.
- **Volume**  
Volume is generally expressed as A-weighted sound level in decibels [dB(A)], as a weighted value above a frequency band.
- **Basic noise level and current activity**  
The buzzing of a mosquito while trying to fall asleep is perceived as a greater disturbance than background traffic noise at the place of work.
- **Personal attitude towards the source of noise**  
The noise produced at a nearby construction site causes a greater disturbance than a concert performed at the same volume.

Sample sound levels:

Sound	Sound level
Jet engine	140 dB(A)
Pop concert	120 dB(A)
Construction site	100 dB(A)
Traffic, motorway	90 dB(A)
Office noise	70 dB(A)
Conference	60 dB(A)
Living space	50 dB(A)
Bedroom	25 dB(A)
Forest	15 dB(A)
Minimum perceptible level	0 dB(A)

### 4.1.1 Superposition of sound sources

Any sound level that results from several superimposing sound sources must be determined logarithmically, not by linear addition.

Superposition of sound levels of varying intensity:

$$L_{\text{total}} = 10 \cdot \log (10^{0.1 \cdot L_1} + 10^{0.1 \cdot L_2} + \dots + 10^{0.1 \cdot L_n}) = 10 \cdot \log \sum_{i=1}^n 10^{\frac{L_i}{10}}$$

Superposition of sound levels of equal intensity:

$$L_{\text{total}} = L + 10 \cdot \log(x)$$

n number of sound sources  
x number of equal sound sources  
L sound pressure level in dB

Examples:

- Varying sound levels of 40 dB, 35 dB and 25 dB produce an overall sound level of 41 dB.
- The overall sound level of three sound levels each measuring 28 dB equates to 33 dB.

# SOUND PROTECTION

## ATTENTION:

At sound levels of approximately 15–30 dB, as they are usual in building engineering, the human ear perceives an increase or reduction by 3–5 dB as double or half the sound impact.

## 4.1.2 Types of sound transmission

Generally, a distinction is made between airborne and structure-borne sound transmission:

- The term **airborne sound** describes sound waves that spread through the air. Airborne sound can be reduced by using materials with high mass density or composite materials with sound-insulating properties (e.g. POLO-KAL pipe systems).
- The term **structure-borne sound** describes sound waves that expand within a solid object. What is audible is usually only the airborne sound that is emitted by the vibrating solid object. Consistent acoustic decoupling can reduce structure-borne sound.

## 4.1.3 The purpose of noise insulation

Sound protective measures in a building pursue the purpose of minimizing noise pollution in rooms. Occupants need to be protected from disturbing airborne sound and impact sound. Architectural sound protection measures apply to buildings and those building elements where people spend longer time periods (offices, flats).

Examples of noise sources in the area of building services:

- Operational noise from plumbing fittings and drainage fixtures
- Operational noise from pumps and ventilation systems
- Flow noise from drinking water and heating system pipes
- Drainage noise from drainage pipes

## 4.1.4 Noise protection during the planning stage

Noise protection for buildings comprises all those planning measures that are suitable for attenuating sound that comes into the building from outside or develops within the building. The situation of the individual rooms in the building, relative to one another, is decisive. Rooms that need to be protected should be situated on the far side away from traffic. Living rooms and sleeping quarters should, as far as possible, be separated from stairways, lifts, etc., by corridors or side rooms. “Noisy” rooms, such as kitchens, WC etc., should not be adjacent to living rooms or sleeping quarters of other flats. And finally, it should be the aim to avoid situating sleeping quarters above or below living rooms of other flats.

In order to provide proper sound protection, several issues must be taken into consideration as early as at the stage of planning and constructing the building:

- Choice of location of the building and its orientation
- Layout design (bathroom, WC, kitchen, lifts relative to sleeping quarters)
- On either side of partition walls or ceilings that separate one flat from another it is advisable to locate rooms of similar use, e.g., kitchens next to/above kitchens; sleeping quarters next to/above sleeping quarters
- Material used for and thickness of partition walls, ceilings
- Walls bordering sanitary installations should not be adjacent to sleeping quarters; if this is not possible, such installations should be sound-proofed by fitting them in “pre-walls”.
- Sound insulation of water/waste water systems.
- Selection of sound-insulating building materials.
- Selection and installation of technical equipment that runs quietly (washing machines, ventilation systems etc.).

# SOUND PROTECTION

STANDARDS, APPROVALS  
AND TESTS

PIPE SYSTEMS

FIRE PROTECTION

SOUND PROTECTION

PIPE INSULATION

PIPE SYSTEM – LAYING  
INSTRUCTIONS

TEXTS FOR TENDERS

## 4.2 The influence of the wall weight on sound protection

**Changes of plumbing noise levels** in the adjacent room (basement, rear), depending on the mass per unit area of a solid plumbing wall with constant sound excitation. The diagram outlines the difference in levels as compared to a plumbing wall with a mass per unit area  $m^2 = 220 \text{ kg/m}^2$ . The calculated results shown in the diagram relate to the conditions of the plumbing test bench in the Fraunhofer Institute for Building Physics and cannot simply be transferred to other building circumstances. The plumbing noise level is even more uncertain for masses per unit area below  $140 \text{ kg/m}^2$  and over  $300 \text{ kg/m}^2$  (coloured zones).

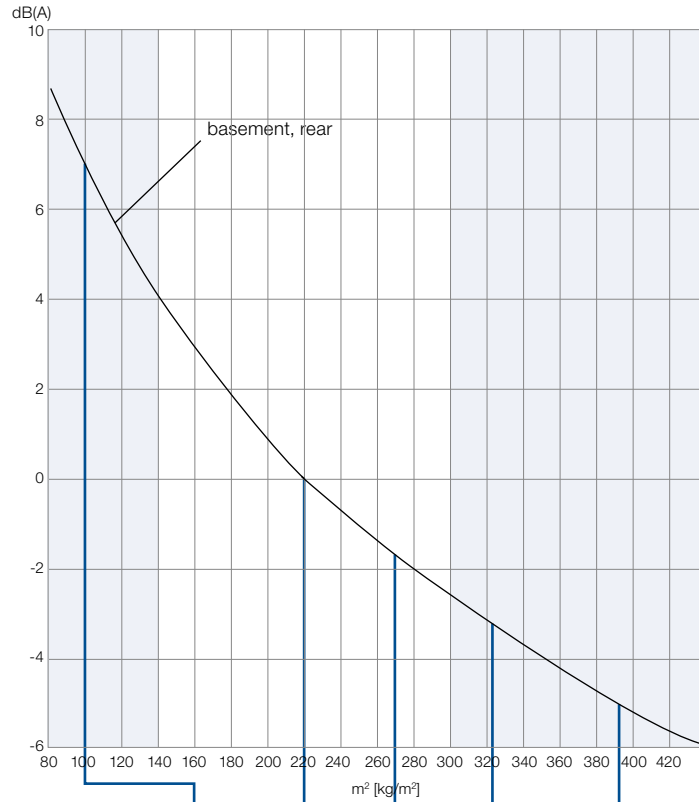

Structural component	Mass
Interior wall (brick 10 cm), plastered	ca. 100 kg/m <sup>2</sup>
Interior wall (brick 25 cm), plastered	ca. 220 kg/m <sup>2</sup>
Exterior wall (brick 25 cm, insulation 15 cm)	ca. 270 kg/m <sup>2</sup>
Exterior wall (brick 30 cm, insulation 20 cm)	ca. 320 kg/m <sup>2</sup>
Reinforced concrete 15 cm	ca. 380 kg/m <sup>2</sup>

The mass values shown above are guide values.

On a case-by-case basis, the mass values of the structural components must be calculated from the manufacturer's information about the materials used.

# SOUND PROTECTION

## 4.3 Sound level measurements

The measurements obtained during independent sound tests at the Fraunhofer Institute in Stuttgart provide impressive proof and confirmation of the high level of POLO-KAL's sound protective competence.

Sound insulation properties were measured and tested according to the currently valid EN 14366 "Bench measurement of noise from building drainage installations". The test results conform to the plumbing noise level  $L_{In}$  as set out by DIN 4109. According to this standard, the noise level in the reception room on the basement level is the measurement that is relevant in practice.

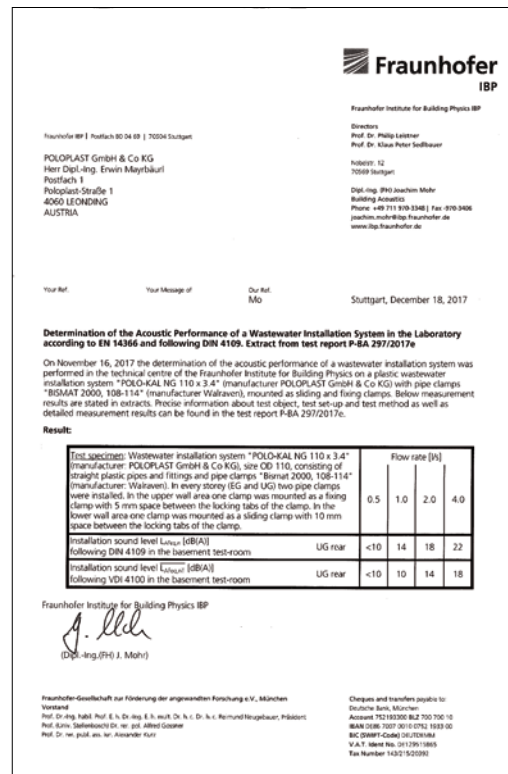

Measurement results	Volume flow	
	2 l/s	4 l/s
<b>POLO-KAL NG</b> fastened with commercially available steel clamps with rubber insert (Bismat 2000) Test report Fraunhofer Institute P-BA 297/2017	<b>18 dB(A)</b>	<b>22 dB(A)</b>
<b>POLO-KAL 3S</b> fastened with commercially available steel clamps with rubber insert (Bismat 2000) Test report Fraunhofer Institute P-BA 297/2017	<b>14 dB(A)</b>	<b>18 dB(A)</b>

STANDARDS, APPROVALS AND TESTS

PIPE SYSTEMS

FIRE PROTECTION

SOUND PROTECTION

PIPE INSULATION

PIPE SYSTEM - LAYING INSTRUCTIONS

TEXTS FOR TENDERS

# SOUND PROTECTION

## Comparability of pipe systems

Test reports in compliance with EN 14366, produced by independent testing institutes, permit the objective comparison of the sound-insulating properties of pipe systems. In order to safeguard the comparability of measurement results, the following information should be noted in the test report:

- **Equivalent fastening system**

(commercially available steel clamps with rubber insert, e.g. Bismat 2000)

Note: POLO-KAL pipe systems can be combined with all fastening clamps currently available.

- **Contrast comparable values**

$L_{in}$  (plumbing sound level in the rear basement)

- **Equal volume flow**

(e.g. 4 l/s)

- **Test arrangement and measurement by an independent testing institute**

(Fraunhofer Institute for Building Physics)

## Sound insulation values in practice

In practice, sound insulation values are influenced by structural conditions, ambient noise, and the quality of the installation, and as such they can deviate from values measured in laboratories. It can generally be assumed that pipe systems with superior test values according to EN 14366 also prove to be quieter in practice. Please refer to the installation advice regarding the professional assembly of steel clamps with rubber inserts on page 61.

# PIPE INSULATION

## 5.1 General information

There are three basic types of insulation, which present different requirements, and for each there is a separate set of products that provide the solution.

## 5.2 Heat insulation

Domestic waste disposal pipes are usually routed within buildings. Even in unheated rooms there is normally no need to protect them from freezing. Therefore heat insulation is of no relevancy to domestic waste disposal pipes. Where trace heating tape is used, the surface temperature of the tape must not exceed 60 °C.

## 5.3 Insulation preventing condensate development

It is necessary to insulate pipes in building engineering systems, if great differences in temperature occur and temperatures drop below the dew point. This can be achieved by using heat insulation with a diffusion-proof outer skin.

For example, interior downpipes (cool rainwater) under a warm hall roof can precipitate condensate. Latent room air moisture develops on the cold outer surface of the pipe.

Suitable 2–3 cm thick insulating material is usually sufficient to prevent the development of condensate. It is important to provide a diffusion-proof skin of the pipe insulation to prevent moisture from entering into the insulating layer.

### Table for the calculation of the dew point temperature in °C

**Example:**

Room temperature 25 °C

Relative air humidity 50 %

Condensate development on the pipe surface 13.9 °C

# PIPE INSULATION

Air °C	Relative air humidity in %													
	30 %	35 %	40 %	45 %	50 %	55 %	60 %	65 %	70 %	75 %	80 %	85 %	90 %	95 %
30	10.5	12.9	14.9	16.8	18.4	20.0	21.4	22.7	23.9	25.1	26.2	27.2	28.2	29.1
29	9.7	12.0	14.0	15.9	17.5	19.0	20.4	21.7	23.0	24.1	25.2	26.2	27.2	28.1
28	8.8	11.1	13.1	15.0	16.6	18.1	19.5	20.8	22.0	23.1	24.2	25.2	26.2	27.1
27	8.0	10.2	12.3	14.1	15.7	17.2	18.6	19.9	21.1	22.2	23.2	24.3	25.2	26.1
26	7.1	9.4	11.4	13.2	14.8	16.3	17.6	18.9	20.1	21.2	22.3	23.3	24.2	25.1
25	6.2	8.5	10.5	12.3	13.9	15.3	16.7	18.0	19.1	20.3	21.3	22.3	23.2	24.1
24	5.4	7.6	9.6	11.3	12.9	14.4	15.8	17.0	18.2	19.3	20.3	21.3	22.3	23.1
23	4.5	6.7	8.7	10.4	12.0	13.5	14.8	16.1	17.2	18.3	19.4	20.3	21.3	22.2
22	3.7	5.9	7.8	9.5	11.1	12.6	13.9	15.1	16.3	17.4	18.4	19.4	20.3	21.2
21	2.8	5.0	6.9	8.6	10.2	11.6	12.9	14.2	15.3	16.4	17.4	18.4	19.3	20.2
20	1.9	4.1	6.0	7.7	9.3	10.7	12.0	13.2	14.4	15.4	16.4	17.4	18.3	19.2
19	1.1	3.2	5.1	6.8	8.4	9.8	11.1	12.3	13.4	14.5	15.5	16.4	17.3	18.2
18	0.2	2.3	4.2	5.9	7.4	8.8	10.1	11.3	12.5	13.5	14.5	15.4	16.3	17.2
17	-0.6	1.5	3.3	5.0	6.5	7.9	9.2	10.4	11.5	12.5	13.5	14.5	15.3	16.2
16	-1.3	0.6	2.4	4.1	5.6	7.0	8.3	9.4	10.5	11.6	12.6	13.5	14.4	15.2
15	-2.1	-0.3	1.5	3.2	4.7	6.1	7.3	8.5	9.6	10.6	11.6	12.5	13.4	14.2
14	-2.9	-1.0	0.6	2.3	3.8	5.1	6.4	7.5	8.6	9.6	10.6	11.5	12.4	13.2
13	-3.7	-1.8	-0.2	1.4	2.8	4.2	5.4	6.6	7.7	8.7	9.6	10.5	11.4	12.2
12	-4.4	-2.6	-1.0	0.5	1.9	3.3	4.5	5.6	6.7	7.7	8.7	9.6	10.4	11.2
11	-5.2	-3.4	-1.8	-0.4	1.1	2.3	3.6	4.7	5.8	6.8	7.7	8.6	9.4	10.2
10	-6.0	-4.2	-2.6	-1.2	0.1	1.4	2.6	3.7	4.8	5.8	6.7	7.6	8.4	9.2
9	-6.8	-5.0	-3.4	-2.0	-0.7	0.5	1.7	2.8	3.8	4.8	5.7	6.6	7.5	8.2
8	-7.5	-5.8	-4.2	-2.8	-1.6	-0.4	0.7	1.8	2.9	3.9	4.8	5.6	6.5	7.3
7	-8.3	-6.6	-5.0	-3.6	-2.4	-1.2	-0.2	0.9	1.9	2.9	3.8	4.7	5.5	6.3
6	-9.1	-7.4	-5.8	-4.4	-3.2	-2.1	-1.0	0.0	1.0	1.9	2.8	3.7	4.5	5.3
5	-9.9	-8.2	-6.6	-5.3	-4.0	-2.9	-1.9	-0.9	0.0	1.0	1.9	2.7	3.5	4.3
4	-10.7	-9.0	-7.4	-6.1	-4.8	-3.7	-2.7	-1.7	-0.8	0.0	0.9	1.7	2.5	3.3
3	-11.5	-9.8	-8.2	-6.9	-5.7	-4.6	-3.5	-2.6	-1.7	-0.9	-0.1	0.7	1.5	2.3
2	-12.3	-10.6	-9.1	-7.7	-6.5	-5.4	-4.4	-3.4	-2.5	-1.7	-0.9	-0.2	0.5	1.3
1	-13.1	-11.4	-9.9	-8.5	-7.3	-6.2	-5.2	-4.3	-3.4	-2.6	-1.8	-1.1	-0.4	0.3
0	-13.9	-12.2	-10.7	-9.4	-8.2	-7.1	-6.1	-5.1	-4.3	-3.4	-2.7	-2.0	-1.3	-0.6

## 5.4 Sound insulation

### 5.4.1 Insulating against airborne noise

If the pipe is located in a room requiring protection (e.g. suspended ceiling), specific sound insulation measures need to be taken. If necessary, they have to be planned separately. In areas that need sound protection, downpipes should, as far as possible, be laid in a vertical direction, without distortion or bypasses.

### 5.4.2 Insulating against structure-borne noise

The fastening material used to mount the pipe on the ceiling or wall must allow structure-borne noise to be decoupled (e.g. POLO-CLIP HS). In apertures in walls and ceilings the pipe has to be sheathed with suitable insulating material (e.g. 4 mm PE hose). Even very small contact points (e.g. instances of mortar residue between pipe and wall) are sufficient to form structure-borne noise bridges. When the pipe is mounted in a pipe pit without being fastened, no all-over pipe damping is required. If the pipe is mounted in chases and plastered afterwards, as well as in cases when the pipe is laid in concrete, it is absolutely necessary to use an insulating hose (4 mm PE) to decouple structure-borne noise.



# PIPE SYSTEM – LAYING INSTRUCTIONS

## 6.1 Transportation and storage

### 6.1.1 Loading and transportation

When loading pipes and fittings take care that no damage can occur during transportation.

Where possible during transportation the pipes should rest in their entire length on top of each other (when no longer in the original packing) so that sagging can be avoided. To do this the sleeves are to be placed offset. Avoid sudden and abrupt stresses on pipes and fittings, especially with temperatures in the frost range.

### 6.1.2 Unloading and storage

Unloading is to be carried out with appropriate care. Do not drop pipes or drag them over the ground. Furthermore, make sure that the pipes are not pulled over sharp edges (e.g. tailgate).

The manner of storage must not cause permanent sagging or damage to the pipes. Unpalletized pipes should not be stacked higher than 1.5 m. By placing the sleeves in an offset position, the individual pipe layers can be almost completely supported. Pipe stacks must be secured against rolling apart.

Short lengths of 150, 250 and 500 mm as well as fittings are packed in cartons. Protect carton-packed pipes and fittings against moisture.

### 6.1.3 Outdoor exposure

POLO-KAL pipes and fittings are designed to withstand outdoor storage:

- POLO-KAL NG: 2 years
- POLO-KAL 3S: 1 year

Longer outdoor storage periods and intense exposure to direct sunlight might lead to discolouration of the surface and to a deterioration of the mechanical material properties.

The sealing material is designed to withstand outdoor storage for three years, after this time the seals must be replaced.

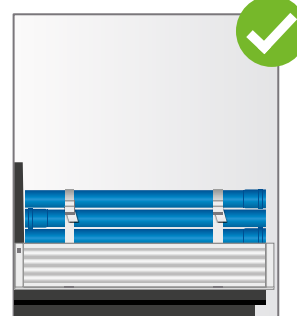

Loading and transportation (FIGURE 14)

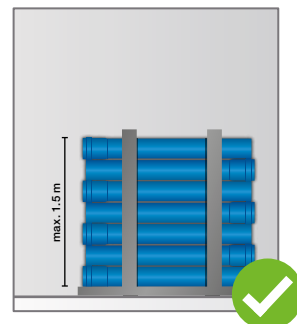

Unloading (FIGURE 15)

# PIPE SYSTEM – LAYING INSTRUCTIONS

## 6.2 Cutting to length and bevelling

### 6.2.1 Cutting to length

Pipes must be cut to length at right angles to the pipe's axis, and can be cut to the required installation length using the following tools:

- Suitable pipe cutter
- Angle grinder
- Fine-toothed saw

The cut edges must be cleanly trimmed with a pipe scraping tool or a knife.

**Fittings must not be shortened.**

### 6.2.2 Bevelling

Expert bevelling is essential for connections with double lip ring seals (e.g. when slip-on or long sleeves are used).

Bevelling of the shortened pipe is necessary when using pipes with a factory installed lip ring, in order to establish a connection quickly and safely.

When not using a cutting and chamfering tool for plastic pipes, the bevelling of the pipe ends can be effected using a suitable chamfering tool or coarse-cut file at an angle of approx. 15° according to the following table:

DN/OD	32	40	50	75	90	110	125	160	200	250
b mm, approx.	4	4	4	4	5	6	6	7	8	10



Cutting to length with a cutting and chamfering tool (FIGURE 16)



Cutting to length with a fine-toothed saw (FIGURE 17)

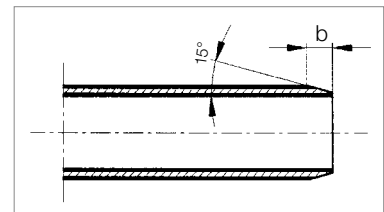

Bevelling at an angle of approx. 15° (FIGURE 18)

# PIPE SYSTEM – LAYING INSTRUCTIONS

## 6.3 Information on push-fit connections

### 6.3.1 Linear expansion in single and multi-family homes

No specific measures for linear expansion are required for pipes laid in the traditional construction of single and multi-family homes at installation temperatures above 15 °C using a pipe length of up to 10 m.

### 6.3.2 Linear expansion in construction projects, commerce and industry

The linear expansion of pipes routed further than 10 m without a change of direction must be checked as required.

In the case of special applications with high wastewater temperatures (commerce, industry) the linear expansion can be calculated as shown below:

**Linear expansion [mm] = LAK [mm/mK] × difference in temperature [Δt] × straight pipe length [m]**

Linear expansion coefficient (LAK):

POLO-KAL NG: 0.05 mm/mK

POLO-KAL 3S: 0.09 mm/mK

Example:

A POLO-KAL NG pipe has a straight length of 15 m. Given an ambient temperature of 10 °C, wastewater is conducted at a maximum temperature of 60 °C. This results in a temperature difference of 50 Kelvin.

Linear expansion [mm] = 0.05 × 50 × 15 = 37.5 mm

A linear expansion of just under 4 cm can thus be expected. Instances of linear expansion can be compensated by drawing out the spigot ends of several push-fit connections by no more than 1 cm. Alternatively, long sleeve sockets can be used in the traditional way.

### 6.3.3 Establishing the push-fit connection

- Check the position and the intactness of the lip ring in the socket flange. Clean lip ring seal if necessary.
- Clean the push-in ends of the pipe and fitting.
- Apply a thin, even coat of POLOPLAST lubricant over the push-in ends.
- Slide push-in end in, turning slightly, until sleeve base is reached.
- If required, mark the pipe at the socket edge with a felt pen and retract the push-fit connection from the socket by 10 mm.
- If using the extraction-proof connection POLO-KAL NG ASV, fittings have to be retracted from the push-fit connection by 5 mm.

# PIPE SYSTEM – LAYING INSTRUCTIONS

## 6.4 Fastening with brackets

### 6.4.1 Arrangement of the brackets

#### Vertical pipe routing

As a principle, 2 brackets are fitted for each floor level: One fixed bracket is fitted to the pipe run below a socket in the lower third of the floor level. The sliding bracket is attached loosely to the plain pipe to allow the linear expansion of the pipe run.

#### Horizontal pipe routing

The pipe run must be secured against lateral shifting or axial extension in the proximity of all points of directional change.

### 6.4.2 Maximum distance between brackets

Nominal outer diameter DN/OD mm	Distance between brackets POLO-KAL pipe systems	
	Horizontal pipe routing L max. m (max. 15 × da)	Vertical pipe routing L max. m
32	0.50	1.50
40	0.60	1.50
50	0.75	1.50
75	1.10	2.00
90	1.35	2.00
110	1.65	2.00
125	1.85	2.00
160	2.40	2.00
200	3.00	2.00
250	3.00	2.00

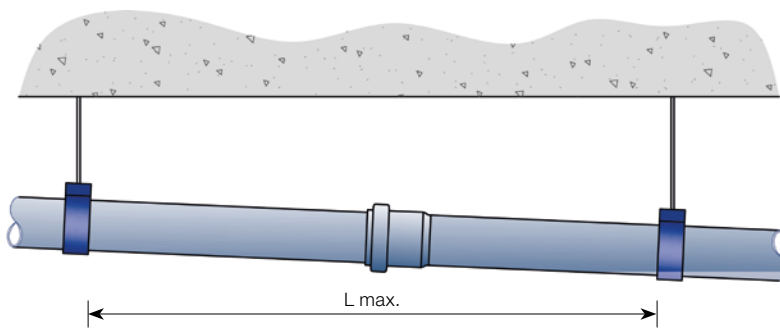

Horizontal pipe routing (FIGURE 19)

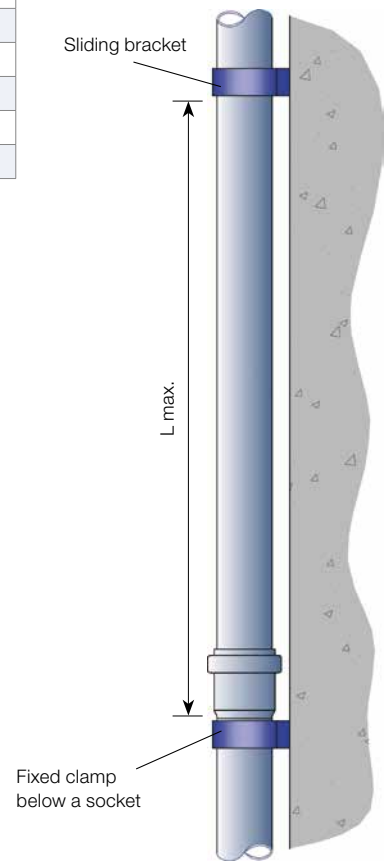

Vertical pipe routing  
(FIGURE 20)

# PIPE SYSTEM – LAYING INSTRUCTIONS

## 6.4.3 The use of steel clamps with rubber inserts

The following additional points must be observed during the professional installation of pipes using steel clamps with rubber inserts:

**Due to the span tolerance (e.g. 108 mm–114 mm in the case of Bismat 2000, DN 110) the fixed bracket must not be fully tightened!**

This represents an installation flaw, which – amongst other things – leads to a significant increase of flow noise transmission to adjacent rooms.

**The sliding bracket should only touch the pipe very lightly.**

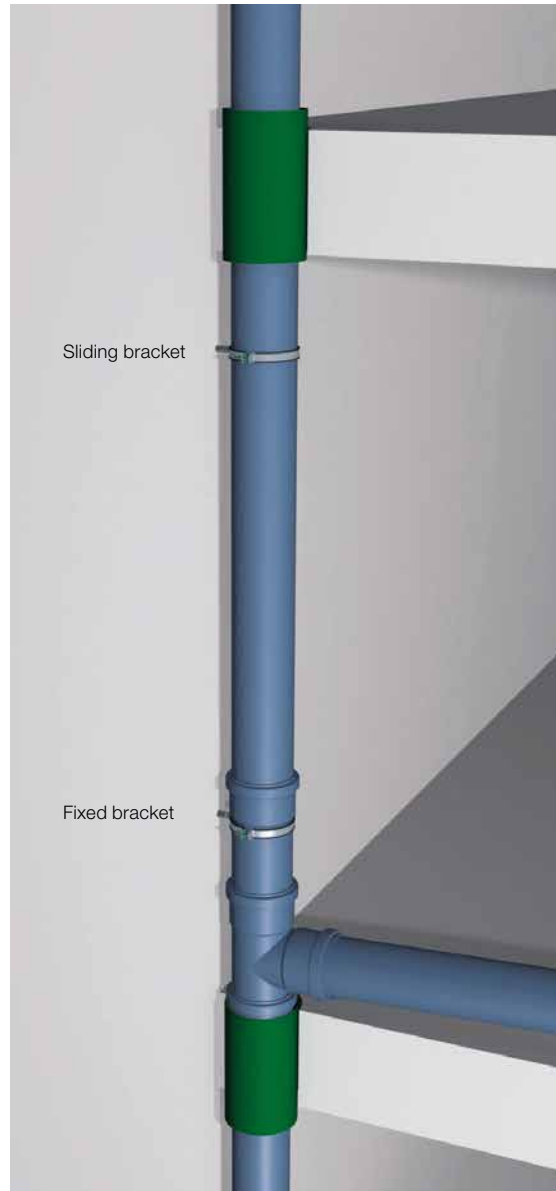

# PIPE SYSTEM – LAYING INSTRUCTIONS

## 6.5 Information on pipe laying

### 6.5.1 Use in commercial kitchens

POLO-KAL NG is basically suitable for the drainage of wastewater containing grease. In general, wastewater temperatures of up to 80 °C can be expected. When using POLO-KAL NG for conducting wastewater or exhaust air in commercial kitchens, the factory-inlaid sealing ring must be replaced with an oil- and grease resistant NBR seal. In accordance with the applicable standard, deposition equipment for wastewater containing grease must be installed and operated as close as possible to the drain point. The inclusion of electrical trace heating leading up to the point of the grease separator is optional. The surface temperature of the electrical trace heating must not exceed 60 °C. According to DIN 1986-100, waste fragmentizers for kitchen waste, which could allow the chopped debris to enter the drainage system, must not be connected to the system.

### 6.5.2 Installing pipes in concrete

POLO-KAL pipes and fittings can be set directly into concrete.

The pipe components are to be fastened in such a way that their position in the concrete cannot change. Pipe ends are to be closed and sleeve socket apertures are to be sealed with adhesive tape or foil to prevent cement slurry from seeping in during cementation and setting.

For soundproofing it is absolutely necessary to sheathe the entire length of piping in insulating material (e.g. 4 mm PE insulation hose).

The change in pipe length, as described above (see chapter 6.3 on push-fit connections), must be taken into account.

### 6.5.3 Wall and ceiling installations

Wall and ceiling installations must be established in a manner that ensures sound-insulation (e.g. 4 mm PE insulation hose).

Where a floating screed is to be applied to a floor, the exposed pipe components are to be sound-proofed by encasing them in soft materials (e.g. glass wool).

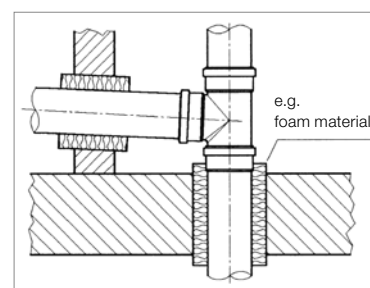

Wall and ceiling installations  
(FIGURE 23)

### 6.5.4 Installing pipes in brickwork (chases)

Chases and apertures in walls are only allowed when they do not cause a reduction in the stability and bearing capacity of supporting walls. Wall kerbings are to be arranged so that the piping can be installed tension-free.

If the pipes are to be plastered immediately, i.e. without using a base or a facing, then the pipes and fittings must be completely wrapped beforehand in suitable materials, such as 4 mm PE insulation hose or 4 mm PE foil (structure-borne sound isolation).

# PIPE SYSTEM – LAYING INSTRUCTIONS

## 6.5.5 Examples of installation in a gap

The installation of building drainage pipes in chases and gaps is very problematic.

As a principle, building drainage pipes can only be installed in chases when a minimum wall weight of  $220 \text{ kg/m}^2$  (or  $350 \text{ kg/m}^2$  when no sound insulation element is used) remains in the chase area on the side facing the room that requires protection (see figure 24).

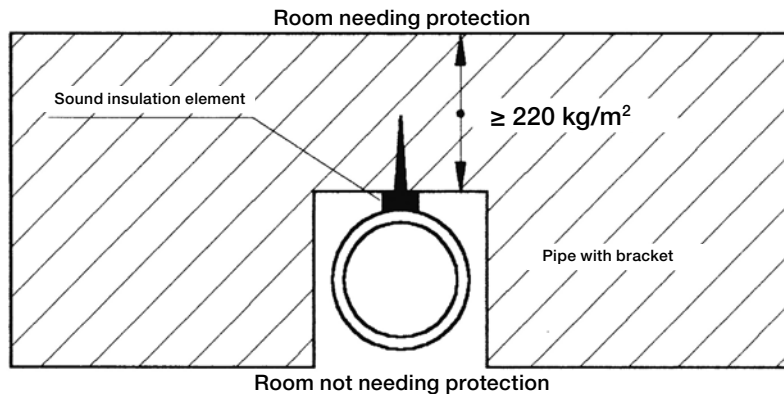

Fastening with sound insulation element (FIGURE 24)

Chases can be faced using a plaster base (plaster base tiles or wire lattice) and a coat of plaster.

Coating can also be carried out with gypsum plaster boards or fibre cement sheets (see figure 25).

No connecting paths (= sound bridges) may develop between building drainage pipe and plaster base.

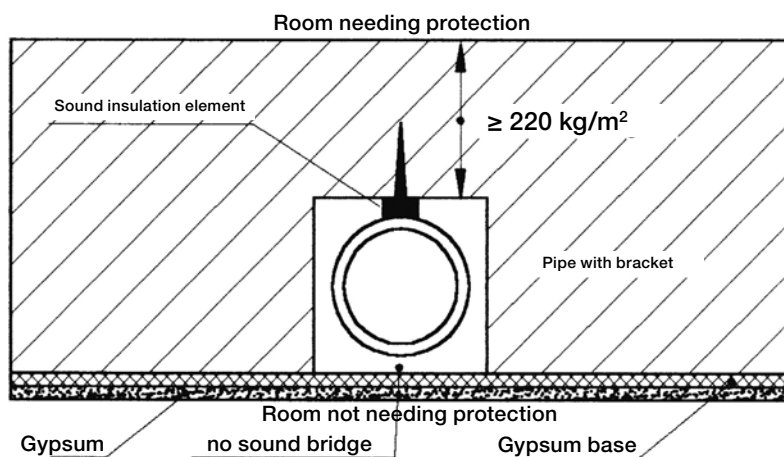

Traditional laying method (FIGURE 25)

To guard against sound bridges between the pipe wall and the building in the case of installation in a gap, building drainage pipes can be fully encased in insulation materials (see figure 26).

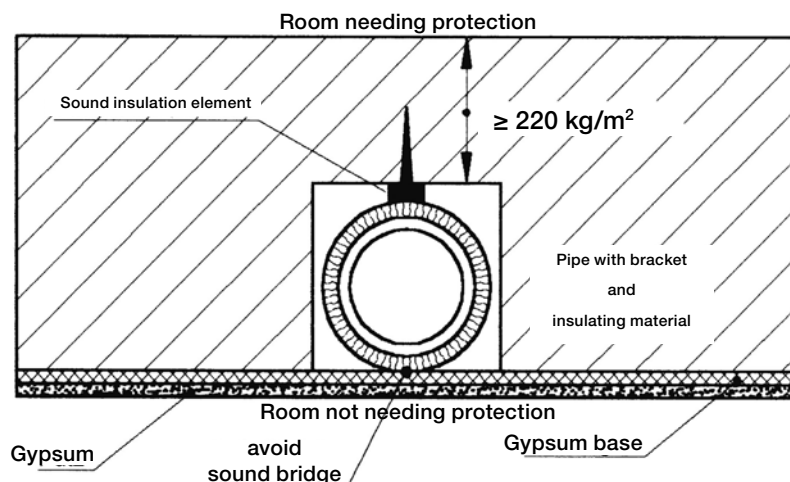

Avoiding impact sound bridges (FIGURE 26)

The works management should check and confirm proper installation before the chases are closed.

# PIPE SYSTEM – LAYING INSTRUCTIONS

## 6.5.6 Laying pipes on unfinished floors

Adequately fasten the pipe in its position with the required gradient. You are advised to observe the fastening distances as stated in paragraph 6.4 “Fastening with brackets”. Besides, measures must be taken to provide decoupling of structure-borne noise (e.g. wedges made of flexible insulating materials). The POLOPLAST installation guidelines see page 62 advises how to achieve a simple and reliable installation on unfinished floors. Pieces of bricks and mortar are not suitable for the purpose of decoupling structure-borne noise. It is advisable to protect the pipes from being pulled apart in areas that are frequently crossed during structural work. This can be done easily and reliably with POLO-KAL NG ASV.

## 6.5.7 Laying pipes in pits

Make sure to lay the pipes without contact to other pipe systems and the structure. The use of an insulating hose is only necessary in the area of ceiling and wall apertures and in places where sound transmission can be expected due to unintentional connection points. A conventional insulating hose is more or less ineffective for purposes of airborne noise reduction.

## 6.5.8 Laying pipes in suspended ceilings

Open pipe laying in rooms that need to be protected should generally be avoided, as experience teaches us that standard sound-insulation requirements cannot be fulfilled. If, due to the building design, it becomes necessary to lay pipes horizontally in a suspended ceiling, additional insulation measures need to be taken.

### Option 1

- insulated suspended ceiling
- sheathe the pipes with sound insulation mat. When downpipes are reversed to a horizontal routing the sound insulation encasement must be used 0.5 m before and at least 3 m behind the bend).

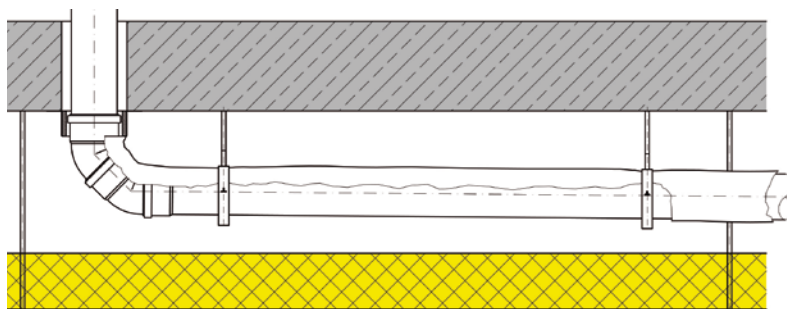

(FIGURE 27)

### Option 2

Enclosure of the entire pipe (e.g. double-planked gypsum plaster board) and stuffing of the cavity with suitable high-density insulating material.

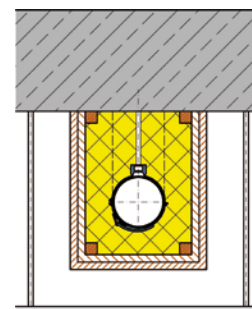

(FIGURE 28)

Note:

The sound values listed in the test report according to EN 14366 refer to a room requiring protection which is located diagonally behind/below the room of transmission. These values are not applicable to the airborne sound values in the transmission room.



# PIPE SYSTEM – LAYING INSTRUCTIONS

## 6.6 Special installation cases

### 6.6.1 Subsequent installation of branch pipes

#### Installation of a branch pipe using two sleeves

When using two sleeve sockets, a piece of pipe of suitable length (the length of the fitting plus twice the outside diameter of the pipe) is cut out, the pipe ends deburred and bevelled and the junction installed.

A sleeve socket is then slid onto the remaining sleeveless pipe end and the sleeveless piece of pipe, respectively.

The piece of pipe is inserted into the gap in the pipe and the connection is closed by sliding both sleeve sockets back (see figure 29).

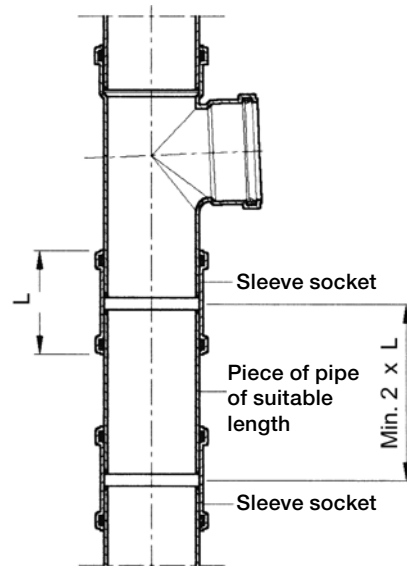

Installation of a branch pipe with 2 sleeve sockets (FIGURE 29)

#### Installation of a branch pipe using a long sleeve and a sleeve socket

If long sleeves are to be used, a piece of pipe is cut out the length of which corresponds to that of the fitting plus push-in depth, the pipe ends are deburred and bevelled and the long sleeve pushed in until it stops.

Push the sleeve over the tapered end of the junction and insert into the pipe.

Then push the tapered end of the long sleeve into the socket of the fitting (see figure 30).

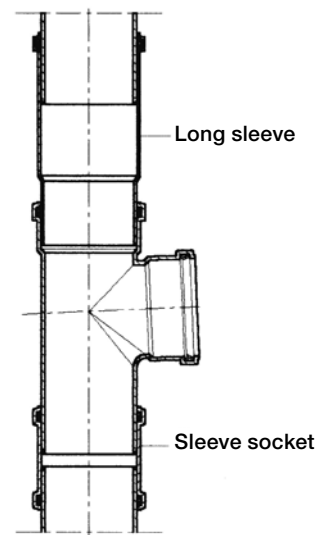

Installation of a junction with long sleeve and sleeve socket (FIGURE 30)

Sleeve sockets and long sleeves are fitted with double lip ring seals, making it easier to push back when retrofitting them.

# PIPE SYSTEM – LAYING INSTRUCTIONS

STANDARDS, APPROVALS  
AND TESTS

PIPE SYSTEMS

FIRE PROTECTION

SOUND PROTECTION

PIPE INSULATION

PIPE SYSTEM – LAYING  
INSTRUCTIONS

TEXTS FOR TENDERS

## 6.6.2 Installing level double corner branch pipes

The POLO-KAL NG level double corner branch allows the lowest possible inclusion of shower and WC in the downpipe. The inclusion point lies just above the unfinished cement floor. This element allows the inclusion in the downpipe in compliance with applicable standards.

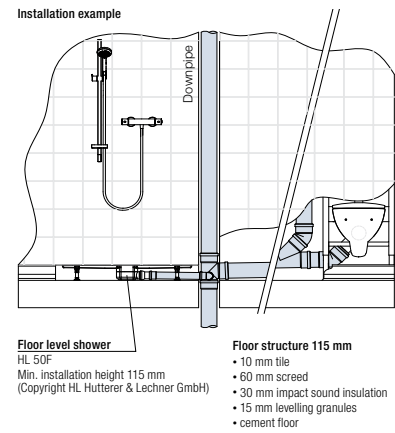

Example of installation of a double corner branch (FIGURE 31)

## 6.6.3 Installing bent double branch pipes

Bent double branches are used as bypasses, e.g. in the area of household plumbing. The flow-enhancing design of the cross section allows several sanitary objects to be connected at the same time. The space-saving building drainage connection is ideal for installation in pipe pits, behind plumbing walls or in sanitary cells.

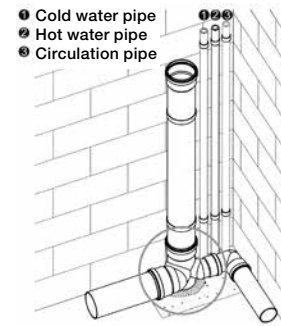

Example of installation of a bent double branch (FIGURE 32)

## 6.6.4 Installing condensate discharge elements

DN/OD	Connection	Item No.
32	8 mm	02356
40	1/2"	02357
50	1/2"	02358

The POLO-KAL NG condensate discharge element serves as a connection to ventilation, condensing value and air conditioning devices. It is a PP part consisting of socket and clip and stands out against traditional connections for condensate discharge elements due to the following advantages: low amount of assembly work involved, no need for tools, compact design.

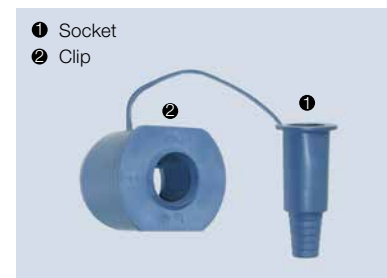

POLO-KAL NG condensate discharge element (FIGURE 33)



Insert the hose into the clip (FIGURE 34)



Insert the socket into the hose end (FIGURE 35)



Push the clip over the socket and clamp the hose (the connecting wire can be severed at any time) (FIGURE 36)



Fit the condensate discharge element into the pipe (FIGURE 37)

# PIPE SYSTEM – LAYING INSTRUCTIONS

## 6.6.5 Installing condensate discharge elements DN 100/ DN/OD 110 to 1/2"

In order to ensure professional discharge of condensate from ventilating pipes (bathroom, WC, kitchen, etc.): POLOPLAST's condensate discharge element for POLO-KAL NG: the leakproof connection to plastics and spiro-tubes!

In practice, condensate discharge devices for ventilating pipes are frequently still made with the aid of sheet metal, silicone, hemp and various other materials. The consequences of such inadequate methods are corrosion and the occurrence of leaks. POLOPLAST's professional solution puts a stop to that: the new POLO-KAL NG condensate discharge element! It guarantees lasting leakproofness and is easy to lay without any tools.

### Assembly using plastic pipes DN/OD 100



POLO-KAL NG condensate discharge element (FIGURE 38)



Insert the hose into the clip (FIGURE 39)



Insert the socket into the hose end as far as possible (FIGURE 40)



Insert the socket into the clip – pull the hose from below to secure a firm connection (FIGURE 41)



Fit the condensate discharge element into the pipe (FIGURE 42)

### Assembly using spiro pipes DN 100



POLO-KAL NG condensate discharge element (FIGURE 43)



Insert the hose into the clip (FIGURE 44)



Insert the socket into the hose end as far as possible (FIGURE 45)



Insert the socket into the clip – pull the hose from below to secure a firm connection (FIGURE 46)



Insert the sealing ring into the clip (FIGURE 47)



Fit the condensate discharge element into the pipe (FIGURE 48)



The sealing ring is generally suitable for use as transition fitting from DN 100, tapered end, to an OD 110 socket (FIGURE 49)

# PIPE SYSTEM – LAYING INSTRUCTIONS

STANDARDS, APPROVALS  
AND TESTS

PIPE SYSTEMS

FIRE PROTECTION

SOUND PROTECTION

PIPE INSULATION

PIPE SYSTEM – LAYING  
INSTRUCTIONS

TEXTS FOR TENDERS

## 6.6.6 Installing inside/inside transition pipes

### Field of application:

- connection to pipe laid in concrete, which terminates flush with the floor
- solution for damaged sockets
- inclusion on unfinished floors

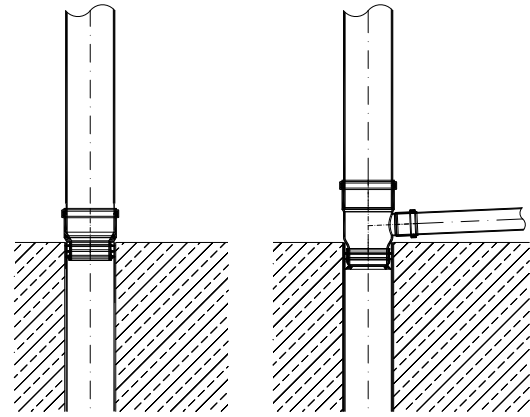

Transition inside/inside

Branch inside/inside

### POLO-KAL NG Branch pipe inside/inside



DN/OD	Item No.
110/50	02369
110/75	02370
110/90	02367
110/110	02381
160/110	02366

### POLO-KAL NG Branch pipe inside/inside



	DN/OD	Item No.
87.5°	110/110/50	01943
	110/110/110	01944

# PIPE SYSTEM – LAYING INSTRUCTIONS

## 6.6.7 Installing circular ventilation bends

1) Circular ventilation bend for the junction of the bypass line and the downpipe.

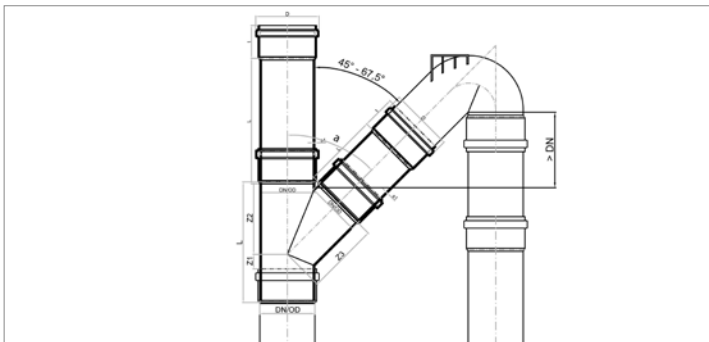

(FIGURE 50)

2) This can also be used as a P trap for WC connection below the floor.

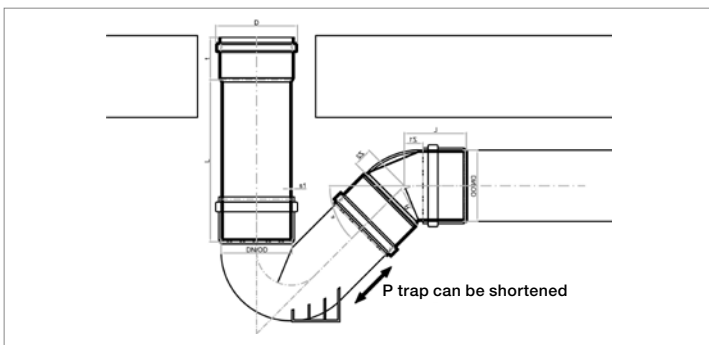

(FIGURE 51)

## 6.6.8 Installing parallel branch pipes

Advantage: low connection height

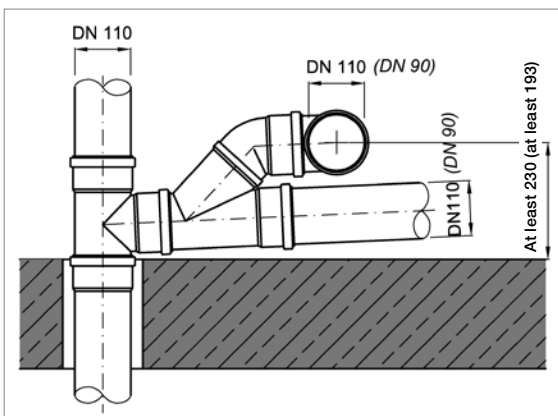

Installation situation with 45° parallel branch (FIGURE 52)

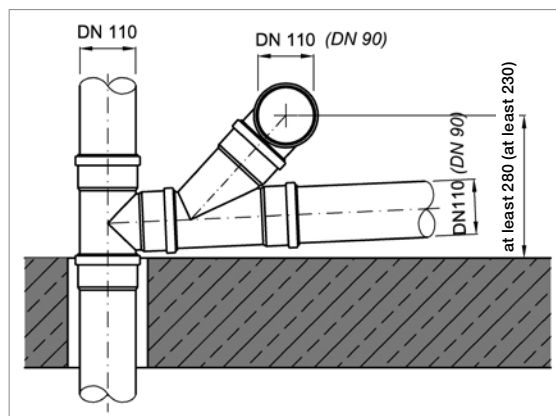

Installation situation with standard branch (FIGURE 53)

# PIPE SYSTEM – LAYING INSTRUCTIONS

## 6.6.9 Welding device for repair work

### Field of application

The repair welding device is used to repair building drainage system pipes made of PP, which have been unintentionally bored through (up to 15 mm). The repair welding device is delivered as a set and consists of:

- Welding case, weight approximately 5 kg
- Heating device 220 V, 600 W
- Saddle heating elements for DN/OD 50–160
- Wooden pressing block for PP welding plugs
- Fastening screw and hexagon socket screw key

### Processing stages

- Corresponding to the outer pipe diameter, a weld element is fastened at the front or side.
- Switch on the device and set it to 225–230 °C (POLO-KAL NG and POLO-KAL 3S pipes). The temperature has been reached when the pilot lamp on the handle is extinguished.
- Deburr the bore hole and clean it (the place to be repaired must be dry and free of oil).
- Put the PP welding plug on the welding device and let it warm up in accordance with the table below.
- Then gently press the welding device together with the weld-on element to the site of repair and allow it to warm up in accordance with the table below.

da	1. stage	2. stage	
	Warm-up time welding plug	Warm-up time repair device + welding plug	E
50	120 sec.	60 sec.	180 sec.
75	110 sec.	70 sec.	180 sec.
90	100 sec.	80 sec.	180 sec.
110	90 sec.	90 sec.	180 sec.

- Remove the repair welding device and the PP welding plug with the wooden pressing block supplied.
- Gently press the wooden pressing block (side of the radius) together with the PP welding plug to the site of repair and hold for approx. 60–90 seconds.
- The repair site can work under full load once the repair site has cooled down (approx. 10 min.)
- Cut off the protruding end (peg).



Welding case (FIGURE 54)



(FIGURE 55)



(FIGURE 56)



(FIGURE 57)

# PIPE SYSTEM – LAYING INSTRUCTIONS

## 6.7 Declaration of Performance (DoP) and CE marking

Following the entry into force of (EU) Regulation No. 305/2011 of the European Parliament, which establishes harmonised conditions for the marketing of construction products as of 01.07.2013, products must be furnished with a CE mark. So-called harmonised standards form the foundation and the prerequisite for this regulation. These harmonised standards have not yet entered into force for the area of building drainage. Therefore, it is currently not possible to provide a CE marking for the POLOPLAST building drainage systems.

STANDARDS, APPROVALS  
AND TESTS

PIPE SYSTEMS

FIRE PROTECTION

SOUND PROTECTION

PIPE INSULATION

PIPE SYSTEM – LAYING  
INSTRUCTIONS

TEXTS FOR TENDERS

## 7.1 Texts for tenders

### 7.1.1 Text modules for POLO-KAL NG

Introductory remarks:

#### Sound absorbing compound waste pipes made of PP-MV.

##### POLO-KAL NG Socket pipe

3-layer, mineral-reinforced compound pipe made of non-halogen plastics, PP inner layer, hot water resistant up to 97 °C, sound-absorbing intermediate layer made of PP-MV mineral-reinforced compound, PP exterior layer.

Minimum rigidity DN/OD 32–160 > 6 kN/m<sup>2</sup>, DN/OD 200 and 250 > 8 kN/m<sup>2</sup>.

Application classification B/D.

Colour: RAL 5014, dove blue.

Moulded connecting sleeve with factory-fitted lip ring, low temperature impact resistant to –20 °C in accordance with EN 1411 average coefficient of linear expansion: LAK 0.05 mm/mK.

Fire behaviour according to EN 13501-1: Classification D-s2, d1

Modulus of elasticity: 2400–3100 MPa according to ISO 178

Leakproof under low pressure to 900 mbar

Product: POLO-KAL NG Socket pipe DN/OD ...

##### POLO-KAL NG Moulded part (bend)

Single layer, mineral-reinforced moulded part made of non-halogen polypropylene with connecting sleeve and factory-fitted lip ring, hot water resistant up to 97 °C.

Product: POLO-KAL NG bend ...° DN/OD ...

##### POLO-KAL NG Moulded part (branch pipe)

Single layer, mineral-reinforced moulded part made of non-halogen polypropylene with connecting sleeve and factory-fitted lip ring, hot water resistant up to 97 °C.

Product: POLO-KAL NG branch pipe ...° DN/OD .../...

##### POLO-KAL NG Moulded part (transition pipe)

Single layer, mineral-reinforced moulded part made of non-halogen polypropylene with connecting sleeve and factory-fitted lip ring, hot water resistant up to 97 °C.

Product: POLO-KAL NG transition pipe DN/OD .../...

##### POLO-KAL NG Moulded part (centric transition pipe with small spigot end)

Single layer, mineral-reinforced moulded part made of non-halogen polypropylene with connecting sleeve and factory-fitted lip ring, hot water resistant up to 97 °C.

Product: POLO-KAL NG centric transition pipe with small spigot end DN/OD .../...

##### POLO-KAL NG Moulded part (double socket)

Single layer, mineral-reinforced moulded part made of non-halogen polypropylene with connecting sleeve and factory-fitted lip ring, hot water resistant up to 97 °C.

Product: POLO-KAL NG double socket DN/OD ...



## **POLO-KAL NG Moulded part (collar)**

Single layer, mineral-reinforced moulded part made of non-halogen polypropylene with connecting sleeve and factory-fitted double lip ring, hot water resistant up to 97 °C.  
Product: POLO-KAL NG collar DN/OD ...

## **POLO-KAL NG Moulded part (long socket)**

Single layer, mineral-reinforced moulded part made of non-halogen polypropylene with connecting sleeve and factory-fitted double lip ring, hot water resistant up to 97 °C.  
Product: POLO-KAL NG long socket DN/OD ...

## **POLO-KAL NG Moulded part (socket plug)**

Single layer, mineral-reinforced moulded part made of non-halogen polypropylene, hot water resistant up to 97 °C.  
Product: POLO-KAL NG socket plug DN/OD ...

## **POLO-KAL NG Moulded part (cleaning pipe)**

Single layer, mineral-reinforced moulded part made of non-halogen polypropylene with connecting sleeve and factory-fitted lip ring, hot water resistant up to 97 °C.  
Product: POLO-KAL NG cleaning pipe DN/OD ...

POLO-EHP control for POLO-KAL NG

Surcharge for the mineral-reinforced multi-layer pipes made of PP-C, PP-TV for a cleaning pipe with large cleaning aperture POLO-EHP control for POLO-KAL NG.

The outer pipe diameter is specified as DN/OD (DN) in mm,

- A POLO-EHP control in blue for POLO-KAL NG DN 110 ..... pieces
- B POLO-EHP control in blue for POLO-KAL NG DN 125 ..... pieces
- C POLO-EHP control in blue for POLO-KAL NG DN 160 ..... pieces
- D POLO-EHP control in blue for POLO-KAL NG DN 200 ..... pieces
- D POLO-EHP control in blue for POLO-KAL NG DN 250 ..... pieces

## **7.1.2 Text modules for POLO-KAL 3S**

Introductory remarks:

### **Sound-absorbing compound waste pipes made of PP.**

#### **POLO-KAL 3S Socket pipe**

3-layer, mineral-reinforced compound pipe made of non-halogen plastics,  
PP inner layer, hot water resistant up to 97 °C, sound-absorbing intermediate layer made of PP-MV,  
mineral-reinforced PP compound, PP exterior layer.

Minimum rigidity DN/OD 75–160 > 4 kN/m<sup>2</sup>.

Application classification B.

Colour: RAL 7053, light grey.

Moulded push-fit socket with factory-fitted lip ring,  
average coefficient of linear expansion: LAK 0.09 mm/m K°.

Fire behaviour according to EN 13501-1: Classification D-s2, d1.

Product: POLO-KAL 3S Socket pipe DN/OD ...

## **POLO-KAL 3S Moulded part (bend)**

Single-layer, mineral-reinforced moulded part made of non-halogen polypropylene with push-fit socket and factory-fitted lip ring, hot water resistant up to 97 °C.

Product: POLO-KAL 3S Bend ...° DN/OD ...

## **POLO-KAL 3S Moulded part (branch)**

Single-layer, mineral-reinforced moulded part made of non-halogen polypropylene with push-fit socket and factory-fitted lip ring, hot water resistant up to 97 °C.

Product: POLO-KAL 3S Branch ...° DN/OD .../...

## **POLO-KAL 3S Moulded part (double branch)**

Single-layer, mineral-reinforced moulded part made of non-halogen polypropylene with push-fit socket and factory-fitted lip ring, hot water resistant up to 97 °C.

Product: POLO-KAL 3S Double branch, independent of branch angle and diameter DN/OD .../.../...

## **POLO-KAL 3S Moulded part (parallel branch)**

Single-layer, mineral-reinforced moulded part made of non-halogen polypropylene with push-fit socket and factory-fitted lip ring, hot water resistant up to 97 °C.

Product: POLO-KAL 3S Parallel branch, independent of branch angle and diameter DN/OD .../...

## **POLO-KAL 3S Moulded part (double corner branch)**

Single-layer, mineral-reinforced moulded part made of non-halogen polypropylene with push-fit socket and factory-fitted lip ring, hot water resistant up to 97 °C.

Product: POLO-KAL 3S Double corner branch, independent of branch angle and diameter DN/OD .../.../...

## **POLO-KAL 3S Moulded part (transition pipe)**

Single-layer, mineral-reinforced moulded part made of non-halogen polypropylene with push-fit socket and factory-fitted lip ring, hot water resistant up to 97 °C.

Product: POLO-KAL 3S Transition pipe DN/OD ... /...

## **POLO-KAL 3S Moulded part (double socket)**

Single-layer, mineral-reinforced moulded part made of non-halogen polypropylene with push-fit socket and factory-fitted lip ring, hot water resistant up to 97 °C.

Product: POLO-KAL 3S Double socket DN/OD ...

## **POLO-KAL 3S Moulded part (collar)**

Single-layer, mineral-reinforced moulded part made of non-halogen polypropylene with push-fit socket and factory-fitted lip ring, hot water resistant up to 97 °C.

Product: POLO-KAL 3S Collar DN/OD ...

## **POLO-KAL 3S Moulded part (socket plug)**

Single-layer, mineral-reinforced moulded part made of non-halogen polypropylene, hot water resistant up to 97 °C.

Product: POLO-KAL 3S Socket plug DN/OD ...

## **POLO-KAL 3S Moulded part (cleaning pipe)**

Single-layer, mineral-reinforced moulded part made of non-halogen plastic polypropylene with push-fit socket and factory-fitted lip ring, hot water resistant up to 97 °C.

Product: POLO-KAL 3S Cleaning pipe DN/OD ...

## **POLO-EHP control for POLO-KAL 3S**

Surcharge for the mineral-reinforced multi-layer pipes made of PP-C, PP-TV for a cleaning pipe with large cleaning aperture POLO-EHP control for POLO-KAL 3S.

The outer pipe diameter is specified as DN/OD (DN) in mm,

A POLO-EHP control in blue for POLO-KAL NG DN 110 ..... pieces

B POLO-EHP control in blue for POLO-KAL NG DN 125 ..... pieces

C POLO-EHP control in blue for POLO-KAL NG DN 160 ..... pieces

## **7.1.3 Text modules for POLO-KAL NG ASV**

### **POLO-ASV (extraction-proof connection)**

Mineral-reinforced plastic claw fastener made of non-halogen plastic PA-GFV, hot water resistant up to 97 °C, minimum protection from extraction depending on dimension 100–600 kg.

Product: POLO-ASV DN/OD ...

## **7.1.4 Text modules for POLO-BSM**

### **POLO-BSM (Fire protective collar)**

System-tested and approved fire protective collar for the pipe systems POLO-KAL NG and POLO-KAL 3S.

System-tested and approved fire protection system for the POLO-KAL NG and POLO-KAL 3S pipe systems where they are ducted through a fire compartment.

Collar body made of sheet steel, starting at temperatures around 150 °C the fire protective compound expands to 10 times its volume producing pressure of up to 10 bar.

Product: POLO-BSM DN/OD ...

## **7.1.5 Text modules for POLO-CLIP HS**

### **POLO-CLIP HS (highly sound insulating pipe fastening system)**

Pipe clamp made of a PP hard component and a TPE soft component in one manufacturing operation (optimally balanced materials providing maximum sound insulation).

Fastening system for POLO-KAL NG or POLO-KAL 3S pipes on walls or ceilings (horizontal or vertical laying) providing optimal sound insulation.

Due to their slanted position and the air cushion in between, the ribs of the soft component part are an optimal sound decoupling element.

The special locking mechanism prevents uncontrolled pressing and securely holds the clamp in its position.

Available with M8 or M10 nut.

Product: POLO-CLIP HS









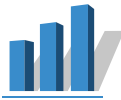

POLOPLAST. A company of **Wietersdorfer**

© Copyright. All contents and graphical representations are protected by copyright and, even in altered form, they may only be reproduced, published or distributed following the express written approval of POLOPLAST.

06/07.18/1.500\_EN\_wanted.co.at

PURE  
PROGRESS / **poloplast**

**POLOPLAST** GmbH & Co KG  
Poloplaststraße 1  
4060 Leonding . Austria  
T +43 (0) 732 . 38 86.0 . F +43 (0) 732 . 38 86.9

office@poloplast.com  
www.poloplast.com